

# **ROBIEL®**

## **INJETORES COMMON RAIL**

Bosch CRI | CRI 1.0 | CRI 2.0 | CRI 2.2

Bosch CRI 2.5

Bosch CRIN 1

Bosch CRIN 2 | CRIN 3

Bosch CRIN 4.2

Caterpillar C4 | C6

Cummins ISX 15 | XPI - Scania

Cummins ISL - Scania

Daf MX13

Delphi HR

Delphi JCB

Denso G2

Denso G2 | G3

Siemens VDO | Continental

UTILIZE A CÂMERA DO SEU CELULAR PARA ESCANEAR O QR CODE E OBTER MAIS INFORMAÇÕES TÉCNICAS DOS PRODUTOS EM NOSSO APLICATIVO **ROBIEL**

BAIXE NOSSO NOVO APP

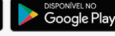
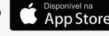

**INJETORES CRI | CRI1.0 | CRI2.0 | CRI2.2**

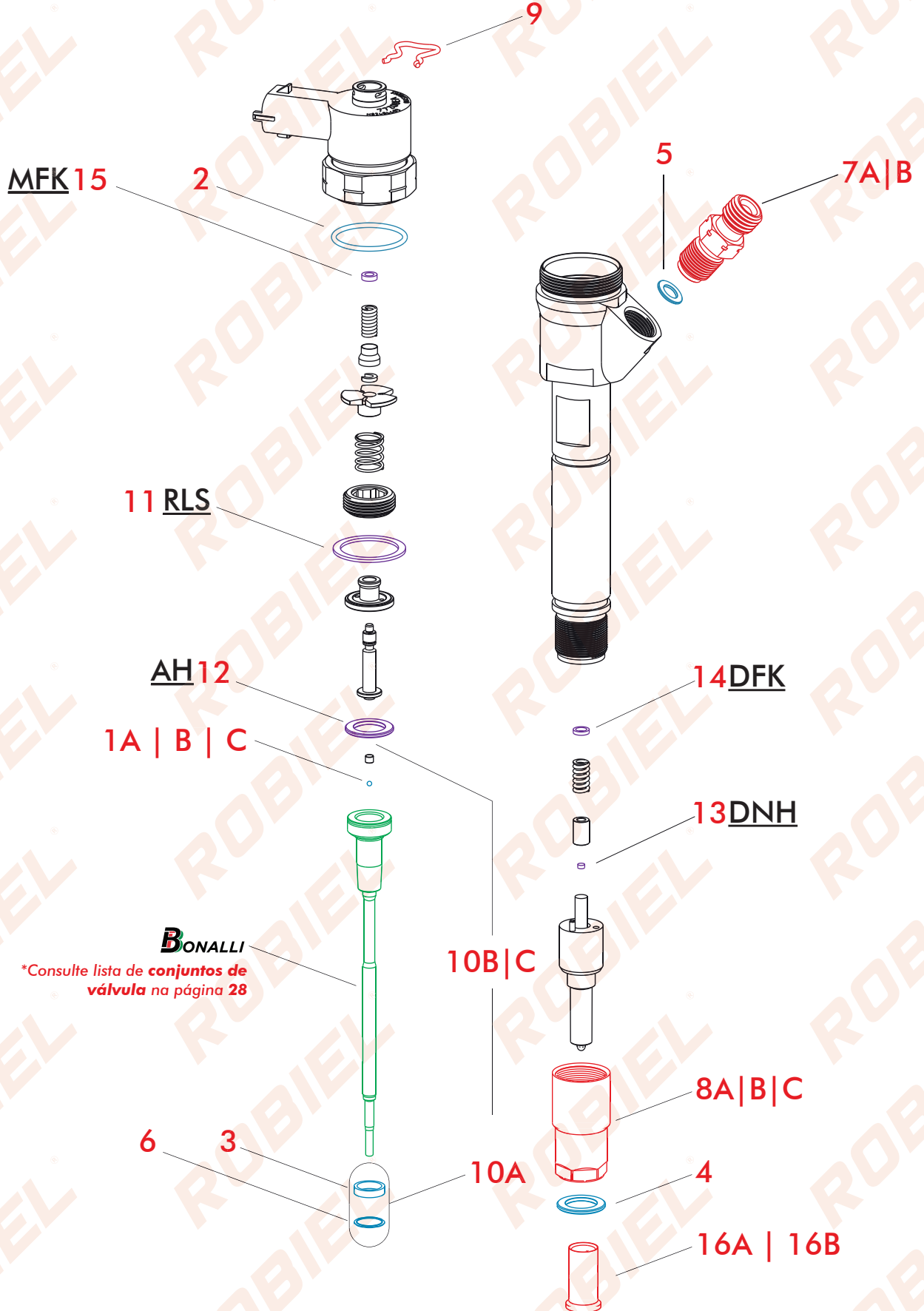

**BONALLI**

\*Consulte lista de conjuntos de válvula na página 28

**410.00.26**

**REPARO INJETOR COMMON RAIL CRI 1.0 ESFERA Ø1,3mm SPRINTER - COMPLETO**

CÓD. REFERÊNCIA				
Nº	CÓD. ROBIEL	REFERÊNCIA	DESCRIÇÃO	EMB.
1A	190.50.11	F 00V C05 001	Esfera	01pç.
2	421.02.115	F 00V C38 002	Anel	01pç.
3	424.08.10	F 00V C99 002	Anel de Teflon	01pç.
4	600.02.02	1 987 972 076 A611 01 70 060	Arruela	01pç.
5	805.09.05	F 00V C17 003	Arruela de Vedação 5,0 x 10,0	01pç.
6	808.10.010	F 00V C99 002	Anel de Aço	01pç.



\* Reparo também aplicado nos injetores 0 445 110 248 e 0 445 110 273 porém é necessário substituir a esfera 190.50.11 pela esfera 190.50.14.

**PEÇAS AVULSAS**

Nº	CÓD. ROBIEL	REFERÊNCIA	DESCRIÇÃO	EMB.
1A	190.50.11	F 00V C05 001	Esfera do Injetor Common Rail Ø 1,34mm	12pç.
1B	190.50.14	F 00V C05 009 006	Esfera dos Injetores 0 445 120 248   273 - Ø 1,50mm	12pç.
1C	190.52.02	-	Esfera Cerâmica Ø 1,50mm	12pç.
4	600.02.02	1 987 972 076 A611 01 70 060	Arruela do Bico Injetor Common Rail	24pç.
5	805.09.05	F 00V C17 003	Calço da Conexão Common Rail	12pç.
7A	165.02.06	F 00V C16 017	Conexão da Pressão do Injetor <small>M12X 1,50mm M12 X 1,00mm</small>	01pç.
7B	165.02.061	-	Conexão c/ Microfiltro Injetores Bosch   Siemens	01pç.
8A	315.06.25	F 00V C14 012	Porca do Bico Sprinter 311 CDI <small>M17 X 0,75mm</small>	04pç.
8B	315.06.58	F 00V C14 015	Porca do Bico Ducato <small>M17 X 0,75mm</small>	01pç.
8C	315.06.64	-	Porca do Bico - Hyundai Kia 2.0   2.2 (Rosca Esquerda)	06pç.
9	335.05.06	F 00V C22 003	Trava do Retorno Sprinter 313 CDI	12pç.
10A	424.08.10C	F 00V C99 002	Reparo do Bastão	04jg.
10B	424.08.10D	F 00V C22 003 + Esfera	Reparo do Bastão com Esfera Ø1,34mm	01jg.
10C	424.08.10E	F 00V C99 002 + Esfera	Reparo do Bastão com Esfera Ø1,50mm	01jg.
16A	220.03.08	F 00R J02 537   F 00R J03 561 6.000.900.262	Capa Protetora do Bico Injetor Ø 7,00mm	01ct.
16B	220.03.09	F 00H 410 849   F 002 C88 080 6.000.900.076	Capa Protetora do Bico Injetor Ø 9,00mm	01ct.
R1	001.08.000	6013.001.121.000	Retorno dos Bicos Volare Motor Sprint 2.7	01pç.
R2	001.08.432	A 611 070 8432	Retorno dos Bicos Sprinter 313 CDI	01pç.
R3	421.00.412	-	Anel da Conexão do Retorno dos Bicos	24pç.
R4	165.06.10	-	Conexão "T" do Retorno dos Bicos	04pç.
R5	165.06.11	-	Conexão "L" do Retorno dos Bicos	04pc.
R6	002.70.0533	-	Cano da Bomba ao Rail Sprinter CDI	01pç.
R7	002.70.0233	611 070 0233	Cano dos Bicos Sprinter CDI	01pç.



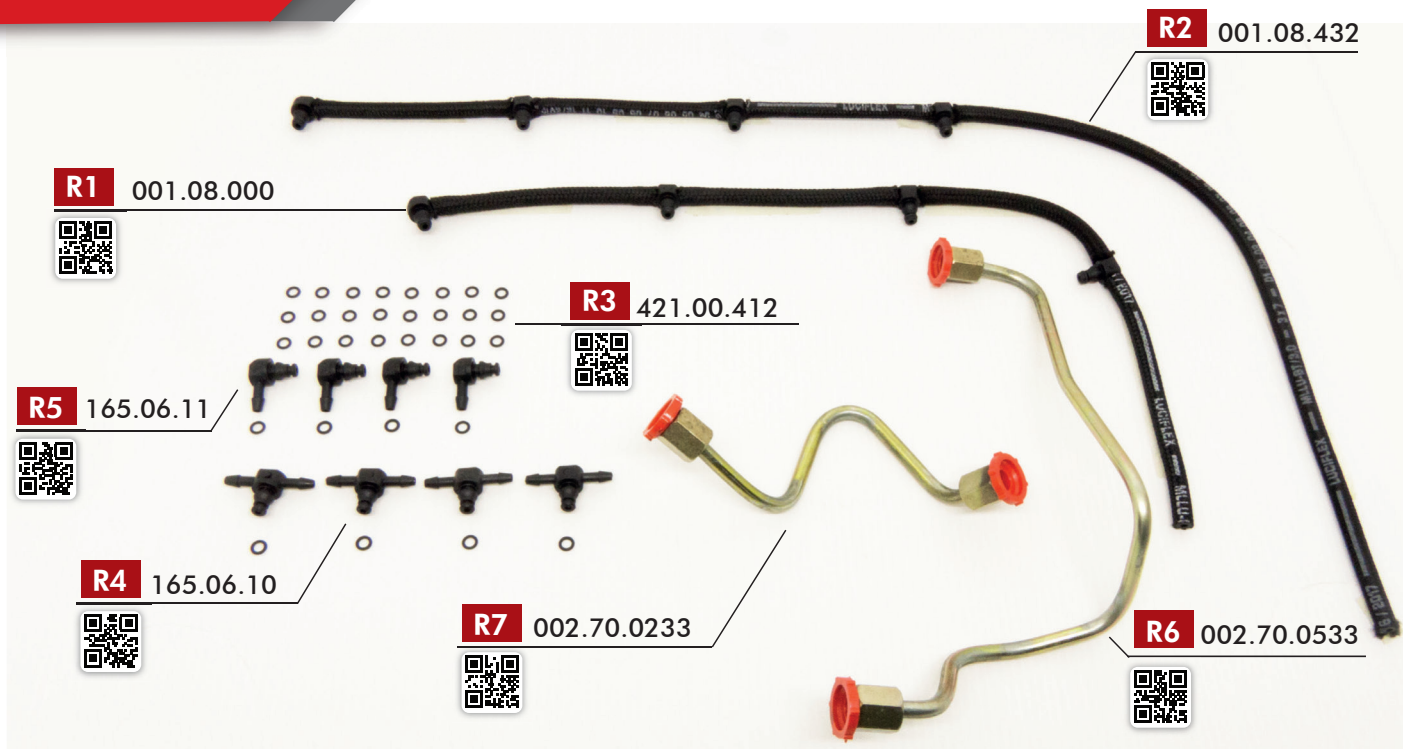

11

**CALÇO DE AJUSTE DA DISTÂNCIA ENTRE BOBINA E INDUZIDO (RLS)**

Ø Interno: 19,00 Ø Externo: 23,80



CÓD. ROBIEL	REFERÊNCIA	ESPESSURA(mm)
819.25.094	F 00V C60 215	0,94
819.25.095	F 00V C60 221	0,95
819.25.096	F 00V C60 225	0,96
819.25.097	-	0,97
819.25.098	F 00V C60 235	0,98
819.25.099	-	0,99
819.25.100	F 00V C60 245	1,00
819.25.101	-	1,01
819.25.102	F 00V C60 255	1,02
819.25.103	-	1,03
819.25.104	F 00V C60 265	1,04
819.25.105	F 00V C60 270	1,05
819.25.106	F 00V C60 275	1,06
819.25.107	F 00V C60 280	1,07
819.25.108	F 00V C60 285	1,08
819.25.110	F 00V C60 295	1,10
819.25.112	-	1,12
819.25.114	-	1,14
819.25.116	-	1,16
819.25.118	-	1,18
819.25.120	-	1,20
819.25.122	-	1,22
819.25.124	-	1,24
819.25.202	-	2,02
819.25.205	-	2,05

EMBALAGEM COM 04 PEÇAS

12

**CALÇO DE AJUSTE DA FOLGA DO CURSO DA MICRO ESFERA (AH)**

Ø Interno: 10,40 Ø Externo: 15,80



CÓD. ROBIEL	REFERÊNCIA	ESPESSURA(mm)
810.16.117	-	1,17
810.16.120	F 00V C10 406	1,20
810.16.121	F 00V C10 410	1,21
810.16.122	F 00V C10 416	1,22
810.16.123	F 00V C10 420	1,23
810.16.124	F 00V C10 426	1,24
810.16.125	F 00V C10 430	1,25
810.16.126	F 00V C10 436	1,26
810.16.127	F 00V C10 440	1,27

EMBALAGEM COM 04 PEÇAS

**13**
**CALÇO DO AJUSTE DO CURSO DA  
AGULHA DO BICO (DNH)**

Ø Externo: 2,30



CÓD. ROBIEL	REFERÊNCIA	ESPESSURA(mm)
800.02.100	F 00V C12 500	1,00
800.02.101	F 00V C12 502	1,01
800.02.102	F 00V C12 504	1,02
800.02.103	F 00V C12 506	1,03
800.02.104	F 00V C12 508	1,04
800.02.105	F 00V C12 510	1,05
800.02.106	F 00V C12 512	1,06
800.02.107	F 00V C12 514	1,07
800.02.108	F 00V C12 516	1,08
800.02.109	F 00V C12 518	1,09
800.02.110	F 00V C12 520	1,10
800.02.111	F 00V C12 522	1,11
800.02.112	F 00V C12 524	1,12
800.02.113	F 00V C12 526	1,13
800.02.114	F 00V C12 528	1,14
800.02.115	F 00V C12 530	1,15
800.02.116	F 00V C12 532	1,16
800.02.117	F 00V C12 534	1,17
800.02.118	F 00V C12 536	1,18
800.02.119	F 00V C12 538	1,19
800.02.120	F 00V C12 540	1,20
800.02.121	F 00V C12 542	1,21
800.02.122	F 00V C12 544	1,22
800.02.123	F 00V C12 546	1,23
800.02.124	F 00V C12 548	1,24
800.02.125	F 00V C12 550	1,25
800.02.126	-	1,26
800.02.127	-	1,27
800.02.133	-	1,33
800.02.134	-	1,34

**EMBALAGEM COM 06 PEÇAS**
**14**
**CALÇO DA FORÇA DA MOLLA DA  
BOBINA INJETOR (DFK)**

Ø Interno: 3,50 Ø Externo: 5,30



CÓD. ROBIEL	REFERÊNCIA	ESPESSURA(mm)
803.05.09	-	0,90
803.05.095	-	0,95
803.05.10	F 00V C10 460	1,00
803.05.105	F 00V C10 464	1,05
803.05.11	F 00V C10 470	1,10
803.05.115	F 00V C10 474	1,15
803.05.12	F 00V C10 480	1,20
803.05.125	F 00V C10 484	1,25
803.05.13	F 00V C10 490	1,30
803.05.135	F 00V C10 494	1,35
803.05.14	F 00V C10 500	1,40
803.05.145	F 00V C10 504	1,45
803.05.15	F 00V C10 510	1,50

**EMBALAGEM COM 06 PEÇAS**
**15**
**CALÇO DA FORÇA DA MOLLA DA  
BOBINA INJETORES CRI 1.0 (MFK)**

Ø Interno: 3,50 Ø Externo: 5,30



CÓD. ROBIEL	REFERÊNCIA	ESPESSURA(mm)
803.05.155	F 00V C10 514	1,55
803.05.16	F 00V C10 520	1,60
803.05.165	F 00V C10 524	1,65
803.05.17	F 00V C10 530	1,70
803.05.175	F 00V C10 534	1,75
803.05.18	F 00V C10 540	1,80
803.05.19	F 00V C10 550	1,90
803.05.20	F 00V C10 560	2,00

**EMBALAGEM COM 06 PEÇAS**
**15**
**CALÇO DA MOLLA DA BOBINA DOS  
INJETORES CRI 2.0 | 2.2 (MFK)**

Ø Interno: 2,80 Ø Externo: 5,00



CÓD. ROBIEL	REFERÊNCIA	ESPESSURA(mm)
803.06.140	F 00V C60 590	1,40
803.06.144	F 00V C60 594	1,44
803.06.148	F 00V C60 598	1,48
803.06.152	F 00V C60 602	1,52
803.06.156	F 00V C60 606	1,56
803.06.160	F 00V C60 610	1,60
803.06.200	-	2,00

**EMBALAGEM COM 12 PEÇAS**



**415.00.011**

**KIT DE CALÇOS PARA REPARAÇÃO DE INJETORES CRI | CRIN**

Nº	CÓDIGOS	DESCRIÇÃO	ESPESSURAS(mm)	Peças por Medida
-	305.20.830 - 305.20.849	Top do Injetor MWM	8,30 à 8,49	12 peças
-	305.30.834 - 305.30.855	Top do Injetor Cummins   Ducato	8,34 à 8,55	12 peças
<b>DNH</b>	800.02.100 - 800.02.125	Calço Restritor do Bico Common Rail	1,00 à 1,25	12 peças
-	802.04.10 - 802.04.125	Calço da Pré-Injeção MWM   Cummins	1,00 à 1,25	12 peças
<b>DFK</b>	803.05.12 - 803.05.19	Calço do Bico Injetor CR   Piezo	1,20 à 1,90	12 peças
<b>MFK</b>	803.06.140 - 803.06.160	Calço da Bobina do Injetor CR Iveco	1,40 à 1,60	12 peças
<b>AH</b>	810.16.117 - 810.16.127	Calço de Pressão Common Rail Sprinter	1,17 à 1,27	12 peças
-	818.24.092 - 818.24.103	Calço do Regulador Common Rail CP3	0,92 à 1,03	12 peças
-	819.24.125 - 819.24.135	Calço do Regulador Common Rail CP3	1,25 à 1,35	12 peças
<b>RLS</b>	819.25.094 - 819.25.110	Calço do Ajuste de Débito CR	0,94 à 1,10	12 peças

**TOTAL DE 1740 PEÇAS**

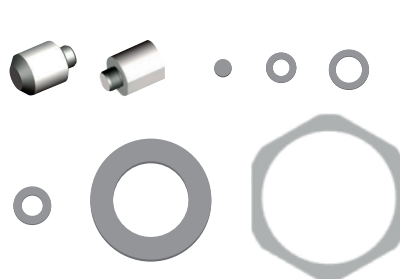

**323.01.3241**

Morsa Giratória para Bancada com Pino Trava



**324.15.01**

Suporte de Montagem e Desmontagem de Injetores



**324.10.10**

Chave da Bucha de Fixação da Válvula 248/273

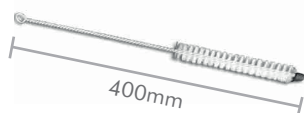

**323.02.121**

Escova para Limpeza e Remoção de Resíduos Ø 12,00mm



**323.50.072**

Kit de Ferramentas para Reparação de Injetores Bosch CRI 1.0 / 2.0 / 2.2 CRIN 1 / 1.16



**323.02.29**

Ferramenta de Teste da Válvula Bastão Common Rail



UTILIZE A CÂMERA DO SEU CELULAR PARA ESCANEAR O QR CODE E OBTER MAIS INFORMAÇÕES TÉCNICAS DOS PRODUTOS EM NOSSO APLICATIVO **ROBIEL**

BAIXE NOSSO NOVO APP

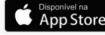

## INJETORES CRI 2.5

Amarok

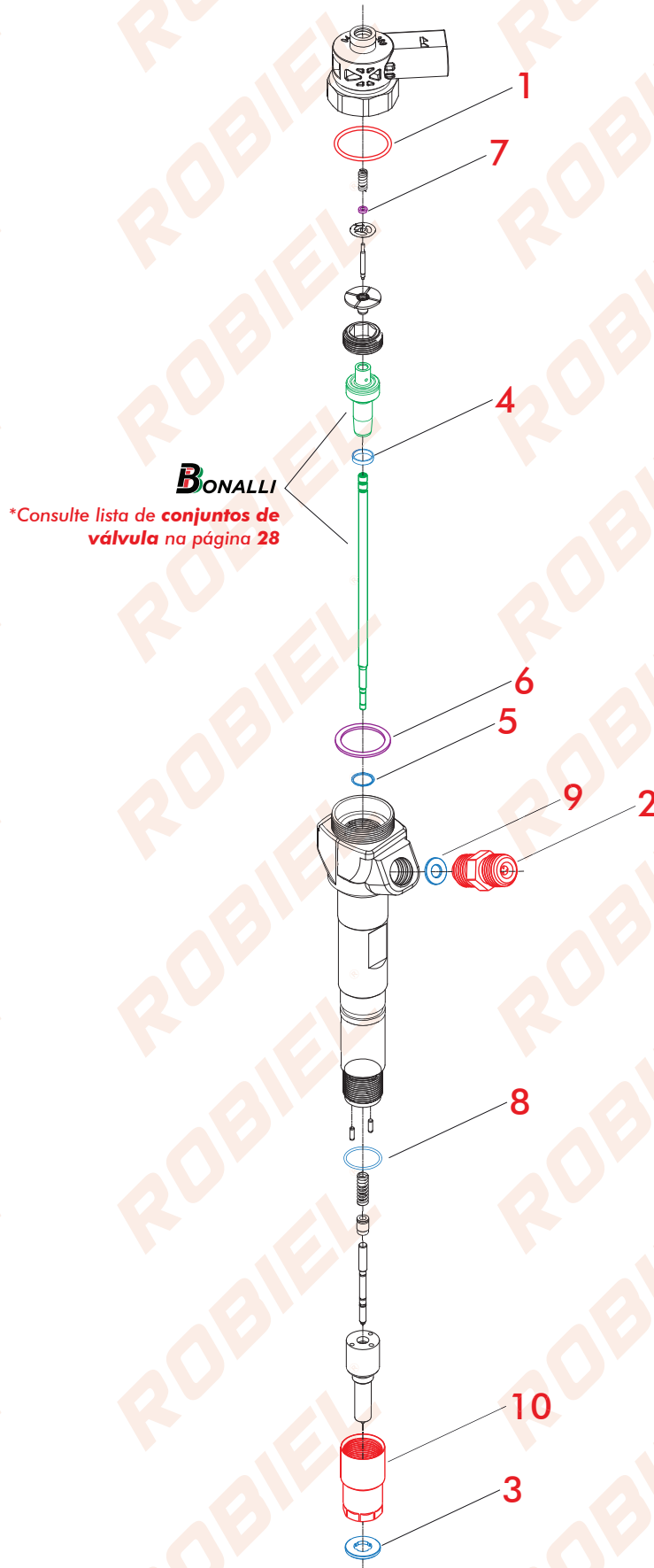

INJETORES

0 445 110 369



**410.08.369**
**REPARO DO INJETOR AMAROK - COMPLETO**

CÓD. REFERÊNCIA				
Nº	CÓD. ROBIEL	REFERÊNCIA	DESCRIÇÃO	EMB.
1	421.02.115	F 00V C38 002	Anel Oring	01pç.
3	607.13.15	F 00V P01 004	Arruela do Bico	01pç.
4	424.08.10	F 00V C99 002	Anel de Teflon	01pç.
5	808.10.010	F 00V C99 002	Anel de Aço	01pç.
8	421.16.15	-	Anel Oring	01pç.



**410.08.001**
**REPARO EXTERNO DO INJETOR AMAROK**

CÓD. REFERÊNCIA				
Nº	CÓD. ROBIEL	REFERÊNCIA	DESCRIÇÃO	EMB.
3	607.13.15	F 00V P01 004	Arruela do Bico	04pç.
8	421.16.15	-	Anel Oring	04pç.



**424.08.10C**
**REPARO DO BASTÃO INJETOR COMMON RAIL**

CÓD. REFERÊNCIA				
F 00V C99 002				
Nº	CÓD. ROBIEL	REFERÊNCIA	DESCRIÇÃO	EMB.
4	424.08.10	F 00V C99 002	Anel de Teflon	04pç.
5	808.10.010	F 00V C99 002	Anel de Aço	04pç.



**PEÇAS AVULSAS**

Nº	CÓD. ROBIEL	REFERÊNCIA	DESCRIÇÃO	EMB.
1	421.02.115	F 00V C38 002	Anel do Solenoide Common Rail	06pç.
2	165.02.17	F 00V C16 501	Conexão com Micro Filtro - Injetor Amarok	01pç.
3	607.13.15	F 00V P01 004	Arruela do Bico Injetor Common Rail - Amarok	06pç.
9	806.12.100	-	Arruela da Conexão Injetor Common Rail - Amarok	12pç.
10	315.06.62	-	Porca do Bico - Amarok	04pç.
R1	001.08.003	03L130235AD	Mangueira de Retorno do Injetor Amarok 2.0 16V - 2012 a 2018	01pç.

**1**

**2**

**3**

**9**

**10**

**R1**

**6**
**CALÇO DE AJUSTE DA DISTÂNCIA  
ENTRE BOBINA E INDUZIDO (RLS)**

Ø Interno: 19,00 Ø Externo: 23,80



CÓD. ROBIEL	REFERÊNCIA	ESPESSURA(mm)
819.25.094	F 00V C60 215	0,94
819.25.095	F 00V C60 221	0,95
819.25.096	F 00V C60 225	0,96
819.25.097	-	0,97
819.25.098	F 00V C60 235	0,98
819.25.099	-	0,99
819.25.100	F 00V C60 245	1,00
819.25.101	-	1,01
819.25.102	F 00V C60 255	1,02
819.25.103	-	1,03
819.25.104	F 00V C60 265	1,04
819.25.105	F 00V C60 270	1,05
819.25.106	F 00V C60 275	1,06
819.25.107	F 00V C60 280	1,07
819.25.108	F 00V C60 285	1,08
819.25.110	F 00V C60 295	1,10
819.25.112	-	1,12
819.25.114	-	1,14
819.25.116	-	1,16
819.25.118	-	1,18
819.25.120	-	1,20
819.25.122	-	1,22
819.25.124	-	1,24
819.25.202	-	2,02
819.25.205	-	2,05

**EMBALAGEM COM 04 PEÇAS**
**7**
**CALÇO DA FORÇA DA  
MOLA DA BOBINA (MFK)**

Ø Interno: 2,25 Ø Externo: 4,00



CÓD. ROBIEL	REFERÊNCIA	ESPESSURA(mm)
802.04.10	F 00R J00 778	1,00
802.04.105	F 00R J00 784	1,05
802.04.11	F 00R J00 787	1,10
802.04.115	F 00R J00 793	1,15
802.04.12	F 00R J00 799	1,20
802.04.125	F 00R J00 802	1,25
802.04.13	F 00R J00 808	1,30
802.04.135	F 00R J00 814	1,35
802.04.14	F 00R J00 817	1,40
802.04.145	F 00R J00 823	1,45
802.04.15	F 00R J00 837	1,50
802.04.155	F 00R J00 840	1,55
802.04.16	F 00R J00 846	1,60
802.04.165	-	1,65
802.04.17	-	1,70

**EMBALAGEM COM 06 PEÇAS**

# CONVERTA CÓDIGOS ORIGINAIS EM CÓDIGOS **ROBIEL**

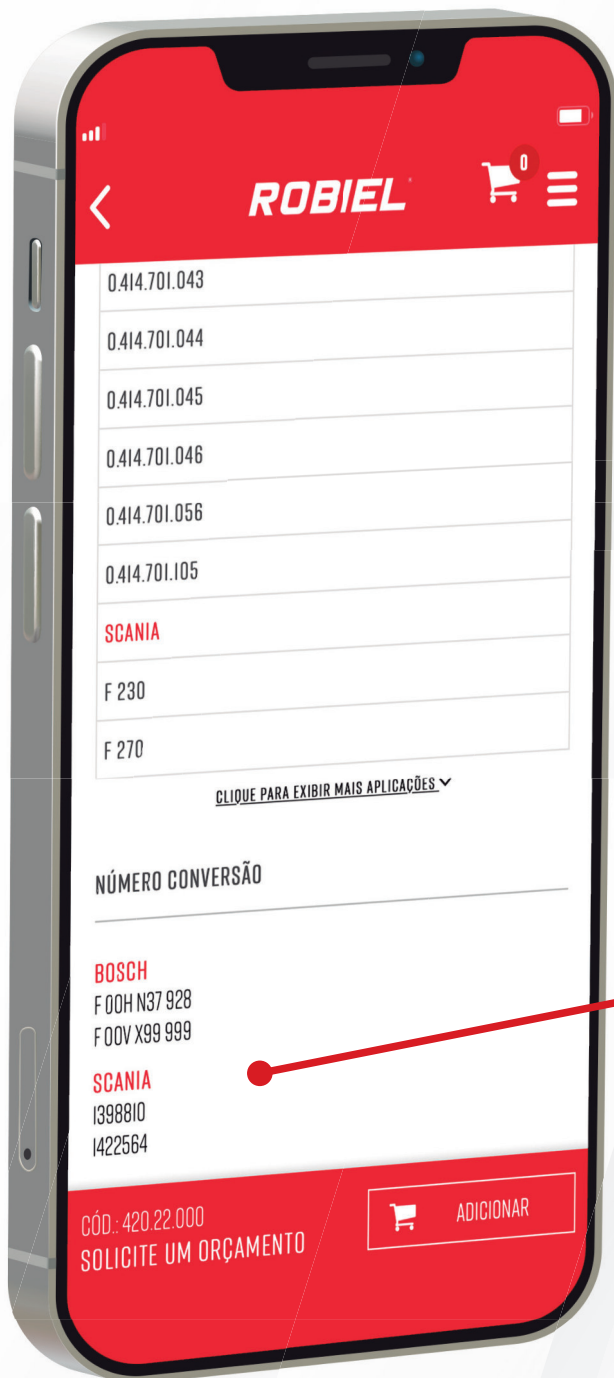

**BAIXE AGORA!**

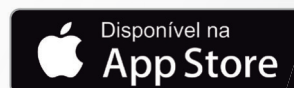

[WWW.ROBIEL.COM](http://WWW.ROBIEL.COM)

UTILIZE A CÂMERA DO SEU CELULAR PARA ESCANEAR O QR CODE E OBTER MAIS INFORMAÇÕES TÉCNICAS DOS PRODUTOS EM NOSSO APLICATIVO **ROBIEL**

BAIXE NOSSO NOVO APP



## INJETORES CRIN

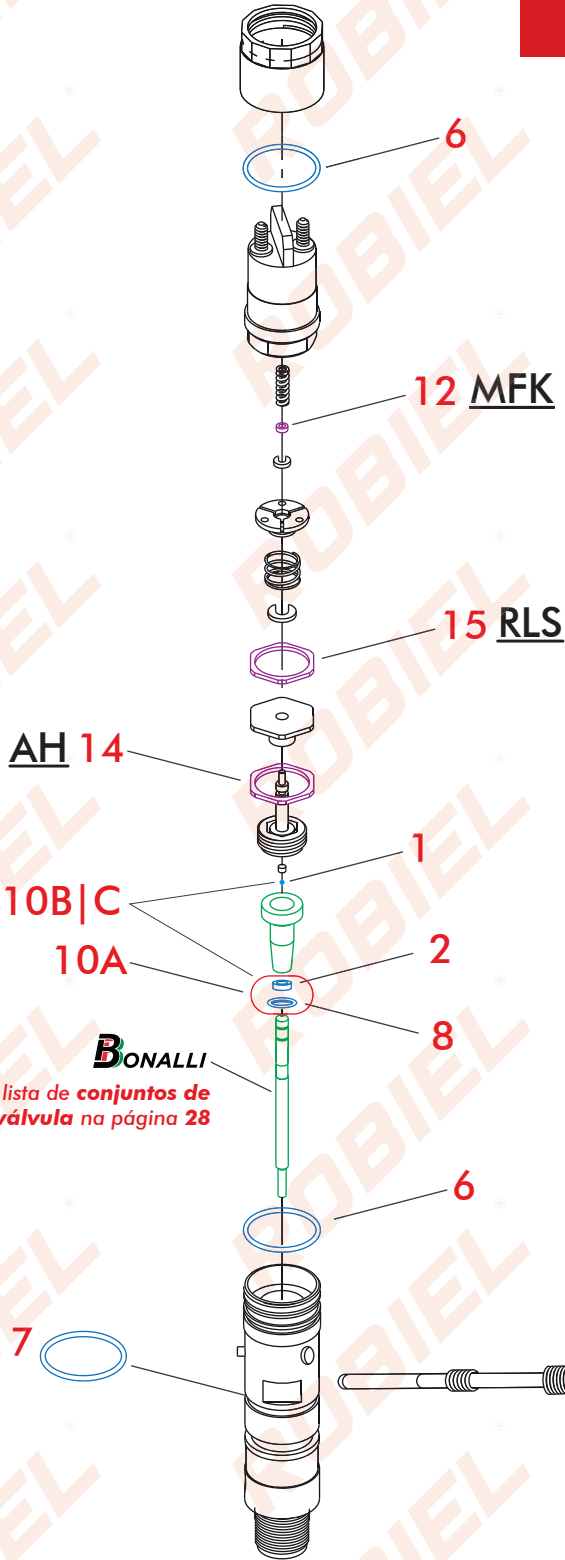

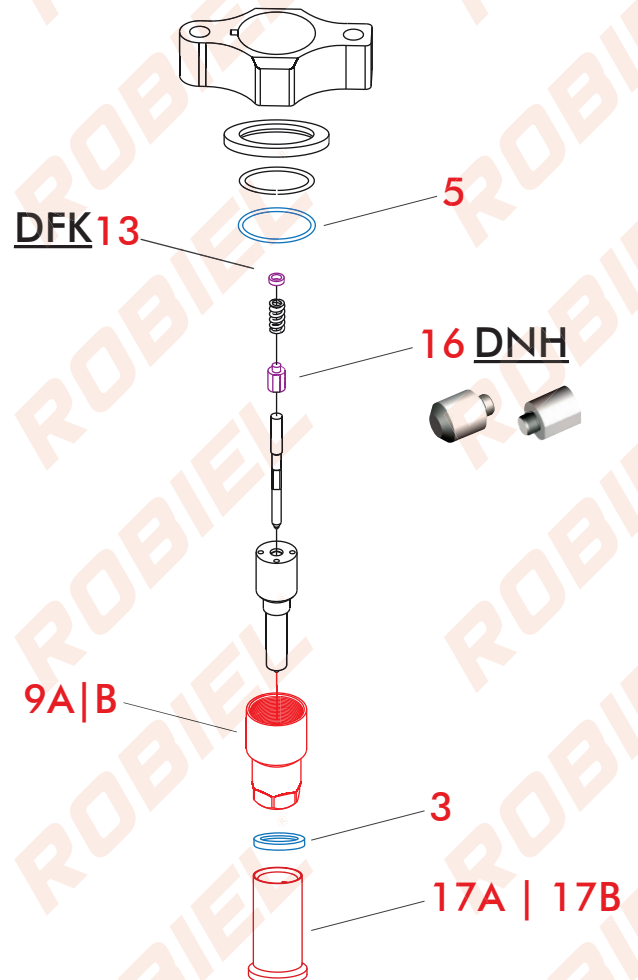

\*Consulte lista de conjuntos de válvula na página 28





**410.00.281**
**REPARO DO INJETOR CRIN - MWM**

CÓD. REFERÊNCIA				
Nº	CÓD. ROBIEL	REFERÊNCIA	DESCRIÇÃO	EMB.
1	190.50.11	F 00V C05 001	Esfera	01pç.
2	424.08.10	F 00V C99 002	Anel de Teflon	01pç.
3	600.02.08	F 00V C17 505 F 00R J01 086	Arruela 7,00x15,00x2,00	01pç.
6	421.02.415	F 00R J00 220	Anel	02pç.
7	421.01.720	-	Anel	01pç.
8	808.10.010	-	Calço	01pç.



**410.00.29**
**REPARO DO INJETOR CRIN - CUMMINS**

CÓD. REFERÊNCIA				
Nº	CÓD. ROBIEL	REFERÊNCIA	DESCRIÇÃO	EMB.
1	190.50.11	F 00V C05 001	Esfera	01pç.
2	424.08.10	F 00V C99 002	Anel de Teflon	01pç.
3	600.02.07	F 00V C17 503 F 00R J01 453	Arruela 7,00x15,00x1,50	01pç.
4	421.01.130	A5419970545	Anel	01pç.
5	421.02.130	A5419970645	Anel	01pç.
6	421.02.415	F 00R J00 220	Anel	02pç.
8	808.10.010	-	Calço	01pç.



**PEÇAS AVULSAS**

Nº	CÓD. ROBIEL	REFERÊNCIA	DESCRIÇÃO	EMB.
1	190.50.11	F 00V C05 001	Esfera do Injetor Common Rail Ø1,34mm	12pç.
3A	600.02.07	F 00V C17 503 F 00R J01 453	Arruela do Porta Injetor Common Rail Cummins - 1,50mm	24pç.
3B	600.02.08	F 00V C17 505 F 00R J01 086	Arruela do Porta Injetor Common Rail MWM - 2,00mm	24pç.
4	421.01.130	2 430 210 082 A5419970545	Anel da Conexão	10pç.
5	421.02.130	2 430 210 081 A5419970645	Anel do Porta Injetor	10pç.
9A	315.06.32	F 00R J00 841	Porca do Bico do Injetor Cummins   CP3 - M19 X 0,75mm	01pç.
9B	315.06.56	F 00R J00 713   F 00R J02 219	Porca do Bico do Injetor MWM 4.12 TCE - M19 X 0,75mm	04pç.
10A	424.08.10C	F 00V C38 002   F 00R J02 176 F 00V C99 002	Reparo do Bastão	04jg.
10B	424.08.10D	F 00V C99 002 + Esfera	Reparo do Bastão com Esfera Ø1,34mm	01jg.
10C	424.08.10E	F 00V C99 002 + Esfera	Reparo do Bastão com Esfera Ø1,50mm	01jg.
11A	165.02.15	Injetores c/ Caneta	Conexão com Microfiltro CR Delphi   Bosch - M14x1,50mm	01pç.
11B	165.02.16	Injetores s/ Caneta	Conexão com Microfiltro Injetores CR MWM - M14x1,50mm	01pç.
17A	220.03.08	F 00R J02 537   F 00R J03 561 6.000.900.262	Capa Protetora do Bico Injetor Ø 7,00mm	01ct.
17B	220.03.09	F 00H 410 849   F 002 C88 080 6.000.900.076	Capa Protetora do Bico Injetor Ø 9,00mm	01ct.





12	CALÇO DA FORÇA DA MOLA DA BOBINA (MFK)		
			
	Ø Interno: 2,25 Ø Externo: 4,00		
○	CÓD. ROBIEL	REFERÊNCIA	ESPESSURA(mm)
	802.04.10	F 00R J00 778	1,00
	802.04.105	F 00R J00 784	1,05
	802.04.11	F 00R J00 787	1,10
	802.04.115	F 00R J00 793	1,15
	802.04.12	F 00R J00 799	1,20
	802.04.125	F 00R J00 802	1,25
	802.04.13	F 00R J00 808	1,30
	802.04.135	F 00R J00 814	1,35
	802.04.14	F 00R J00 817	1,40
	802.04.145	F 00R J00 823	1,45
	802.04.15	F 00R J00 837	1,50
	802.04.155	F 00R J00 840	1,55
	802.04.16	F 00R J00 846	1,60
	802.04.165	-	1,65
	802.04.17	-	1,70
<b>EMBALAGEM COM 06 PEÇAS</b>			

13	CALÇO DA FORÇA DA MOLA DO BICO (DFK)		
			
	Ø Interno: 3,50 Ø Externo: 5,30		
○	CÓD. ROBIEL	REFERÊNCIA	ESPESSURA(mm)
	803.05.09	-	0,90
	803.05.095	-	0,95
	803.05.10	F 00V C10 460	1,00
	803.05.105	F 00V C10 464	1,05
	803.05.11	F 00V C10 470	1,10
	803.05.115	F 00V C10 474	1,15
	803.05.12	F 00V C10 480	1,20
	803.05.125	F 00V C10 484	1,25
	803.05.13	F 00V C10 490	1,30
	803.05.135	F 00V C10 494	1,35
	803.05.14	F 00V C10 500	1,40
	803.05.145	F 00V C10 504	1,45
	803.05.15	F 00V C10 510	1,50
	803.05.155	F 00V C10 514	1,55
	803.05.16	F 00V C10 520	1,60
	803.05.165	F 00V C10 524	1,65
	803.05.17	F 00V C10 530	1,70
	803.05.175	F 00V C10 534	1,75
	803.05.18	F 00V C10 540	1,80
	803.05.19	F 00V C10 550	1,90
	803.05.20	F 00V C10 560	2,00
<b>EMBALAGEM COM 06 PEÇAS</b>			

**TABELA DE INJETORES**

Restritor	Restritor	Restritor	Restritor	Restritor	Restritor	Restritor	Pino Intermediário	Pino Intermediário	Pino Intermediário
CRIN 1   1.6	CRIN 1   1.6	CRIN 1   1.6	CRIN 1   1.6	CRIN 1   1.6	CRIN 1   1.6	CRIN 1   1.6	CRIN 1   1.6	CRIN 1   1.6	CRIN 1   1.6
0 445 120 025	0 445 120 040	0 445 120 108	0 445 120 133	0 445 120 208	0 445 120 250	0 445 120 330	0 445 120 009	0 445 120 119	0 445 120 079
0 445 120 029	0 445 120 041	0 445 120 112	0 445 120 140	0 445 120 209	0 445 120 251	Pino Intermediário	0 445 120 010	0 445 120 020	0 445 120 084
0 445 120 031	0 445 120 051	0 445 120 115	0 445 120 144	0 445 120 210	0 445 120 252	CRIN 1   1.6	0 445 120 011	0 445 120 021	0 445 120 085
0 445 120 033	0 445 120 052	0 445 120 119	0 445 120 151	0 445 120 211	0 445 120 253	0 445 120 002	0 445 120 012	0 445 120 022	0 445 120 089
0 445 120 034	0 445 120 059	0 445 120 120	0 445 120 152	0 445 120 212	0 445 120 254	0 445 120 003	0 445 120 013	0 445 120 028	0 445 120 103
0 445 120 035	0 445 120 060	0 445 120 121	0 445 120 159	0 445 120 231	0 445 120 255	0 445 120 004	0 445 120 014	0 445 120 032	0 445 120 113
0 445 120 036	0 445 120 70	0 445 120 122	0 445 120 173	0 445 120 238	0 445 120 256	0 445 120 005	0 445 120 015	0 445 120 043	0 445 120 114
0 445 120 037	0 445 120 094	0 445 120 123	0 445 120 174	0 445 120 239	0 445 120 272	0 445 120 006	0 445 120 016	0 445 120 046	-
0 445 120 038	0 445 120 096	0 445 120 125	0 445 120 175	0 445 120 240	0 445 120 273	0 445 120 007	0 445 120 017	0 445 120 069	-
0 445 120 039	0 445 120 097	0 445 120 132	0 445 120 176	0 445 120 241	0 445 120 300	0 445 120 008	0 445 120 018	0 445 120 077	-

15

**CALÇO DA DISTÂNCIA ENTRE BOBINA E INDUZIDO (RLS)**

Ø Interno: 19,00 Ø Externo: 24,00



CÓD. ROBIEL	REFERÊNCIA	ESPESSURA(mm)
819.24.100	-	1,00
819.24.102	-	1,02
819.24.104	-	1,04
819.24.106	-	1,06
819.24.108	-	1,08
819.24.110	-	1,10
819.24.112	-	1,12
819.24.114	-	1,14
819.24.116	-	1,16
819.24.125	F 00R J00 128	1,25
819.24.126	F 00R J00 130	1,26
819.24.127	F 00R J00 132	1,27
819.24.128	F 00R J00 134	1,28
819.24.129	F 00R J00 136	1,29
819.24.130	F 00R J00 138	1,30
819.24.131	F 00R J00 140	1,31
819.24.132	F 00R J00 142	1,32
819.24.133	F 00R J00 144	1,33
819.24.134	F 00R J00 146	1,34
819.24.135	F 00R J00 148	1,35

EMBALAGEM COM 04 PEÇAS



14

**CALÇO DO CURSO DO INDUZIDO (AH)**

Ø Interno: 18,00 Ø Externo: 24,00



CÓD. ROBIEL	REFERÊNCIA	ESPESSURA(mm)
818.24.085	-	0,85
818.24.088	-	0,88
818.24.092	-	0,92
818.24.093	-	0,93
818.24.094	-	0,94
818.24.095	F 00R J00 024	0,95
818.24.096	-	0,96
818.24.097	F 00R J00 034	0,97
818.24.098	-	0,98
818.24.099	F 00R J00 044	0,99
818.24.100	-	1,00
818.24.101	F 00R J00 054	1,01
818.24.102	-	1,02
818.24.103	F 00R J00 064	1,03
818.24.105	F 00R J00 074	1,05
818.24.107	F 00R J00 084	1,07
818.24.109	F 00R J00 094	1,09

EMBALAGEM COM 04 PEÇAS



**16**
**TOP DO INJETOR MWM P/ MEDIR  
O CURSO DA AGULHA DO BICO (DNH)**

CÓD. ROBIEL	REFERÊNCIA	ESPESSURA(mm)
305.20.830	F 00V C12 408	8,30
305.20.831	F 00V C12 412	8,31
305.20.832	F 00V C12 416	8,32
305.20.833	F 00V C12 420	8,33
305.20.834	-	8,34
305.20.835	F 00V C12 424	8,35
305.20.836	F 00V C12 428	8,36
305.20.837	F 00V C12 432	8,37
305.20.838	F 00V C12 436	8,38
305.20.839	-	8,39
305.20.840	F 00V C12 440	8,40
305.20.841	F 00V C12 444	8,41
305.20.842	F 00V C12 448	8,42
305.20.843	F 00V C12 452	8,43
305.20.844	F 00V C12 456	8,44
305.20.845	F 00V C12 460	8,45
305.20.846	-	8,46
305.20.847	F 00V C12 464	8,47
305.20.848	F 00V C12 468	8,48
305.20.849	F 00V C12 472	8,49

**EMBALAGEM COM 04 PEÇAS**
**16**
**TOP INJETOR CUMMINS|DUCATO P/ MEDIR  
O CURSO DA AGULHA DO BICO (DNH)**



CÓD. ROBIEL	REFERÊNCIA	ESPESSURA(mm)
305.30.834	F 00V C12 322	8,34
305.30.835	F 00V C12 324	8,35
305.30.836	F 00V C12 328	8,36
305.30.837	F 00V C12 332	8,37
305.30.838	F 00V C12 334	8,38
305.30.839	F 00V C12 338	8,39
305.30.840	F 00V C12 340	8,40
305.30.841	F 00V C12 344	8,41
305.30.842	F 00V C12 348	8,42
305.30.843	F 00V C12 352	8,43
305.30.844	F 00V C12 354	8,44
305.30.845	F 00V C12 358	8,45
305.30.846	F 00V C12 362	8,46
305.30.847	F 00V C12 364	8,47
305.30.848	F 00V C12 368	8,48
305.30.849	F 00V C12 372	8,49
305.30.850	F 00V C12 374	8,50
305.30.851	F 00V C12 378	8,51
305.30.852	F 00V C12 382	8,52
305.30.853	F 00V C12 384	8,53
305.30.854	F 00V C12 388	8,54
305.30.855	F 00V C12 392	8,55

**EMBALAGEM COM 04 PEÇAS**

**415.00.011** KIT DE CALÇOS PARA REPARAÇÃO DE INJETORES CRI | CRIN

Nº	CÓDIGOS	DESCRIÇÃO	ESPESSURAS(mm)	Peças por Medida
DNH	305.20.830 - 305.20.849	Top do Injetor MWM	8,30 à 8,49	12 peças
DNH	305.30.834 - 305.30.855	Top do Injetor Cummins   Ducato	8,34 à 8,55	12 peças
-	800.02.100 - 800.02.125	Calço Restritor do Bico Common Rail	1,00 à 1,25	12 peças
MFK	802.04.10 - 802.04.125	Calço da Pré-Injeção MWM   Cummins	1,00 à 1,25	12 peças
DFK	803.05.12 - 803.05.19	Calço do Bico Injetor CR   Piezo	1,20 à 1,90	12 peças
-	803.06.140 - 803.06.160	Calço da Bobina do Injetor CR Iveco	1,40 à 1,60	12 peças
-	810.16.117 - 810.16.127	Calço de Pressão Common Rail Sprinter	1,17 à 1,27	12 peças
AH	818.24.092 - 818.24.103	Calço do Regulador Common Rail CP3	0,92 à 1,03	12 peças
RLS	819.24.125 - 819.24.135	Calço do Regulador Common Rail CP3	1,25 à 1,35	12 peças
-	819.25.094 - 819.25.110	Calço do Ajuste de Débito CR	0,94 à 1,10	12 peças

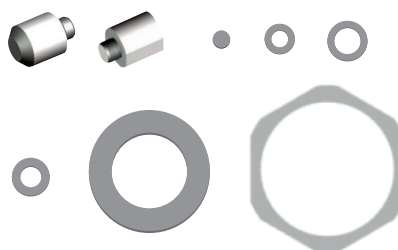
**TOTAL DE 1740 PEÇAS**



**323.01.3241**

Morsa Giratória para Bancada com Pino Trava



**324.15.01**

Suporte de Montagem e Desmontagem de Injetores

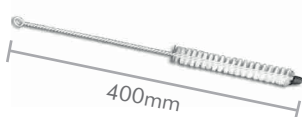

**323.02.121**

Escova para Limpeza e Remoção de Resíduos Ø 12,00mm



**323.50.072**

Kit de Ferramentas para Reparação de Injetores Bosch CRI 1.0 / 2.0 / 2.2 CRIN 1 / 1.16



**323.02.29**

Ferramenta de Teste da Válvula Bastão Common Rail



UTILIZE A CÂMERA DO SEU CELULAR PARA ESCANEAR O QR CODE E OBTER MAIS INFORMAÇÕES TÉCNICAS DOS PRODUTOS EM NOSSO APLICATIVO **ROBIEL**

BAIXE NOSSO NOVO APP

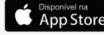

**INJETORES CRIN 2**

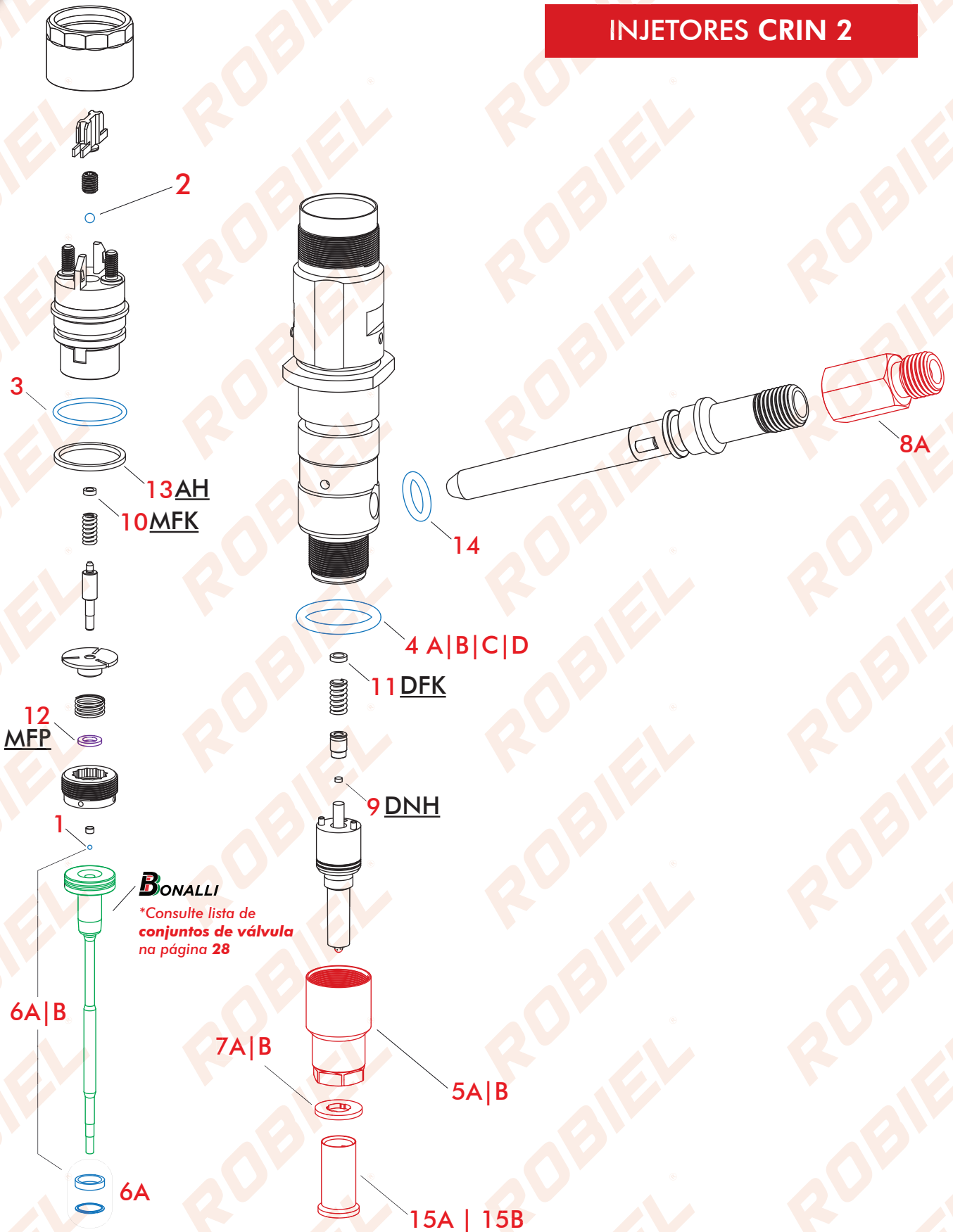

UTILIZE A CÂMERA DO SEU CELULAR PARA ESCANEAR O QR CODE E OBTER MAIS INFORMAÇÕES TÉCNICAS DOS PRODUTOS EM NOSSO APLICATIVO **ROBIEL**

BAIXE NOSSO NOVO APP



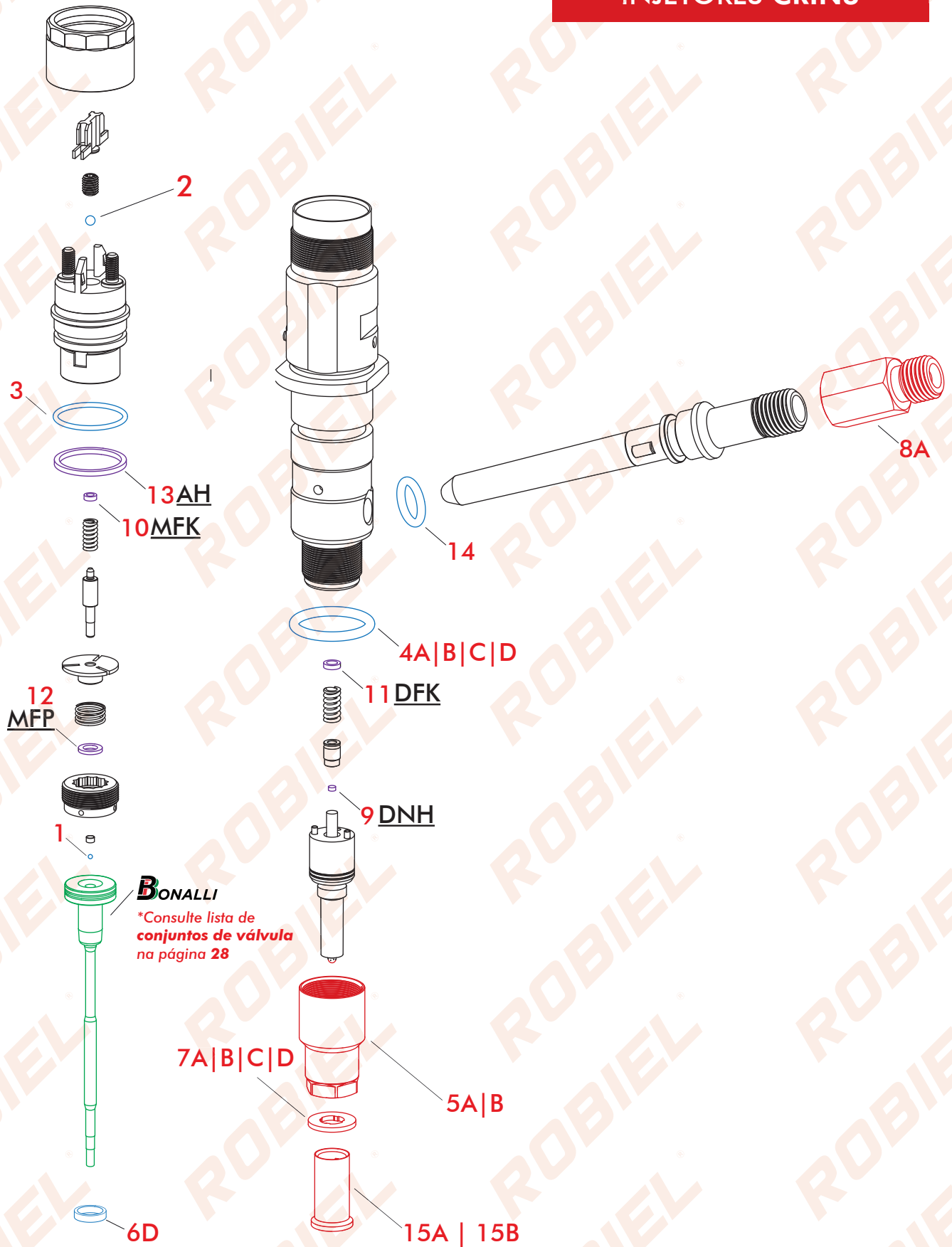

**INJETORES CRIN3**





**410.00.37**
**REPARO DO INJETOR COMMON RAIL CRIN 2 EURO 5**



APLICAÇÃO		CUMMINS		
Nº	CÓD. ROBIEL	REFERÊNCIA	DESCRIÇÃO	EMB.
1	190.50.11	F 00V C05 001	Esfera Ø 1,35mm	01pç.
2	190.50.16	F 00R C00 556	Esfera Ø 3,00mm	01pç.
3	421.02.015	F 00R J00 222	Anel	01pç.
4B	421.02.130	2 430 210 081	Anel	01pç.
14	421.01.130	2 430 210 082	Anel	01pç.
6A	424.08.10C	F 00V C99 002 F 00R J02 176	Anel	01jg.
7A	600.02.07	F 00V C17 503 F 00R 501 453	Arruela 7,0 X 15,0 X 1,5	01pç.



**410.00.38**
**REPARO DO INJETOR COMMON RAIL CRIN 3 EURO 5**



APLICAÇÃO		CUMMINS		
Nº	CÓD. ROBIEL	REFERÊNCIA	DESCRIÇÃO	EMB.
1	190.50.11	F 00V C05 001	Esfera	01pç.
2	190.50.16	F 00R C00 556	Esfera	01pç.
6D	424.07.917	F 00R J02 177	Anel	01pç.
4B	421.02.130	2 430 210 081	Anel	01pç.
14	421.01.130	2 430 210 082	Anel	01pç.
3	421.02.015	F 00R J00 222	Anel	01pç.
7A	600.02.07	F 00V C17 503 F 00R 501 453	Arruela 7,0 X 15,0 X 1,5	01pç.



**410.00.39**
**REPARO DO INJETOR COMMON RAIL CRIN 3 EURO 5**

APLICAÇÃO		MWM		
Nº	CÓD. ROBIEL	REFERÊNCIA	DESCRIÇÃO	EMB.
1	190.50.11	F 00V C05 001	Esfera	01pç.
2	190.50.16	F 00R C00 556	Esfera	01pç.
3	421.02.015	F 00R J00 222	Anel	01pç.
6D	424.07.917	F 00R J02 177	Anel	01pç.
4C	421.01.720	-	Anel	01pç.
7B	600.02.08	F 00V C17 505 F 00R J01 086	Arruela 7,0 X 15,0 X 2,0	01pç.

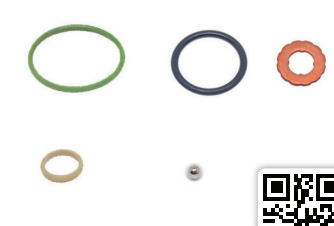

**410.00.40**
**REPARO DO INJETOR MAN COMMON RAIL CRIN 3**

INJETORES		0 445 120 162   0 445 120 186		
Nº	CÓD. ROBIEL	REFERÊNCIA	DESCRIÇÃO	EMB.
1	190.50.11	F 00V C05 001	Esfera	01pç.
2	190.50.16	F 00R C00 556	Esfera	01pç.
3	421.02.015	F 00R J00 222	Anel	01pç.
4D	421.02.430	F 00R J00 534	Anel	01pç.
6D	424.07.917	F 00R J02 177	Anel	01pç.
7D	600.02.10	F 00R J02 175	Arruela	01pç.

**410.00.41 REPARO DO INJETOR MAN COMMON RAIL CRIN 2**

INJETORES		0 445 120 044   0 445 120 045   0 445 120 055		
Nº	CÓD. ROBIEL	REFERÊNCIA	DESCRIÇÃO	EMB.
1	190.50.11	F 00V C05 001	Esfera	01pç.
2	190.50.16	F 00R C00 556	Esfera	01pç.
3	421.02.015	F 00R J00 222	Anel	01pç.
4D	421.02.430	F 00R J00 534	Anel	01pç.
6A	424.08.10C	F 00V C99 002 F 00R J02 176	Reparo do Bastão	01pç.
7D	600.02.10	F 00R J02 175	Arruela	01pç.



**410.20.092 REPARO DO INJETOR COMMON RAIL CRIN 2 | 3**

APLICAÇÃO		IVECO   CASE NH		
Nº	CÓD. ROBIEL	REFERÊNCIA	DESCRIÇÃO	EMB.
1	190.50.11	F 00V C05 001	Esfera Ø 1,35mm	01pç.
2	190.50.16	F 00R C00 556	Esfera Ø 3,00mm	01pç.
3	421.02.015	F 00R J00 222	Anel	01pç.
4A	421.02.835	-	Anel	01pç.

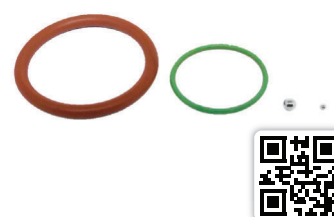

**PEÇAS AVULSAS**

Nº	CÓD. ROBIEL	REFERÊNCIA	DESCRIÇÃO	EMB.
1	190.50.11	F 00V C05 001	Esfera do Injetor Common Rail Ø 1,35mm	12pç.
5A	315.06.56	F 00R J00 713   F 00R J02 219	Porca do Bico Injetor CRIN 3 Euro 5	04pç.
5B	315.06.57	F 00R J00 842	Porca do Bico Injetor 0 445 120 092   157   279   002	01pç.
6A	424.08.10C	F 00V C99 002   F 00R J02 176	Reparo do Bastão	04ig.
6B	424.08.10D	F 00V C99 002 + Esfera	Reparo do Bastão com Esfera Ø1,34mm	01ig.
6C	424.08.10E	F 00V C99 002 + Esfera	Reparo do Bastão com Esfera Ø1,50mm	01ig.
6D	424.07.917	F 00R J02 177	Anel Bastão do Injetor CRIN 3	06pç.
7A	600.02.07	F 00V C17 503   F 00R J01 453	Arruela 7,0 X 15,0 X 1,5	24pç.
7B	600.02.08	F 00V C17 505   F 00R J01 086	Arruela 7,0 X 15,0 X 2,0	24pç.
7C	600.07.17	CASE 504 262 598	Arruela Cônica do Injetor CASE MAGNUN MX235	12pç.
7D	600.02.10	F 00R J02 175	Arruela do bico injetor Man	06pç.
8A	165.02.15	Injetores c/ Caneta	Conexão com Microfiltro CR Delphi   Bosch M14x1,50mm	01pç.
8B	165.02.16	Injetores s/ Caneta	Conexão com Microfiltro Injetores CR MWM M14x1,50mm	01pç.
15A	220.03.08	F 00R J02 537   F 00R J03 561 6.000.900.262	Capa Protetora do Bico Injetor Ø 7,00mm	01ct.
15A	220.03.09	F 00H 410 849   F 002 C88 080 6.000.900.076	Capa Protetora do Bico Injetor Ø 9,00mm	01ct.
R1	421.02.430	F 00R J00 534	Anel Externo Injetor Man	06pç.

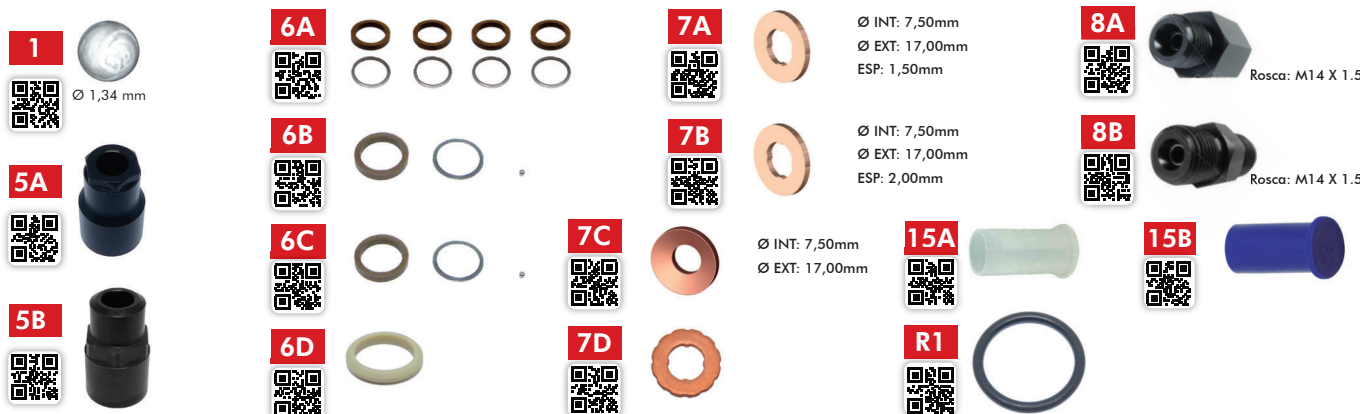

9	CALÇO DO AJUSTE DO CURSO DA AGULHA DO BICO (DNH)		
	Ø Externo: 2,30		
●	CÓD. ROBIEL	REFERÊNCIA	ESPESSURA(mm)
	800.02.110	F 00V C12 520	1,10
	800.02.113	F 00V C12 526	1,13
	800.02.115	F 00V C12 530	1,15
	800.02.118	F 00V C12 536	1,18
	800.02.120	F 00V C12 540	1,20
	800.02.123	F 00V C12 546	1,23
	800.02.125	F 00V C12 550	1,25
<b>EMBALAGEM COM 06 PEÇAS</b>			

11	CALÇO DA FORÇA DA MOLA DO BICO (DFK)		
	Ø Interno: 3,50 Ø Externo: 5,30		
○	CÓD. ROBIEL	REFERÊNCIA	ESPESSURA(mm)
	803.05.07	-	0,70
	803.05.075	-	0,75
	803.05.08	-	0,80
	803.05.085	-	0,85
	803.05.09	-	0,90
	803.05.095	-	0,95
	803.05.10	F 00V C10 460	1,00
	803.05.105	F 00V C10 464	1,05
	803.05.11	F 00V C10 470	1,10
	803.05.115	F 00V C10 474	1,15
	803.05.12	F 00V C10 480	1,20
	803.05.125	F 00V C10 484	1,25
	803.05.13	F 00V C10 490	1,30
	803.05.135	F 00V C10 494	1,35
	803.05.14	F 00V C10 500	1,40
	803.05.145	F 00V C10 504	1,45
	803.05.15	F 00V C10 510	1,50
	803.05.155	F 00V C10 514	1,55
	803.05.16	F 00V C10 520	1,60
	803.05.165	F 00V C10 524	1,65
	803.05.17	F 00V C10 530	1,70
	803.05.175	F 00V C10 534	1,75
	803.05.18	F 00V C10 540	1,80
	803.05.19	F 00V C10 550	1,90
	803.05.20	F 00V C10 560	2,00
<b>EMBALAGEM COM 06 PEÇAS</b>			

10	CALÇO DA FORÇA DA MOLA DA BOBINA (MFK)		
	Ø Interno: 2,25 Ø Externo: 4,00		
○	CÓD. ROBIEL	REFERÊNCIA	ESPESSURA(mm)
	802.04.10	F 00R J00 778	1,00
	802.04.105	F 00R J00 784	1,05
	802.04.11	F 00R J00 787	1,10
	802.04.115	F 00R J00 793	1,15
	802.04.12	F 00R J00 799	1,20
	802.04.125	F 00R J00 802	1,25
	802.04.13	F 00R J00 808	1,30
	802.04.135	F 00R J00 814	1,35
	802.04.14	F 00R J00 817	1,40
	802.04.145	F 00R J00 823	1,45
	802.04.15	F 00R J00 837	1,50
	802.04.155	F 00R J00 840	1,55
	802.04.16	F 00R J00 846	1,60
	802.04.165	-	1,65
	802.04.17	-	1,70
<b>EMBALAGEM COM 06 PEÇAS</b>			

12	CALÇO DO MOVIMENTO DA PLACA FLUTUANTE (MFP)		
	Ø Interno: 4,50 Ø Externo: 7,70		
○	CÓD. ROBIEL	REFERÊNCIA	ESPESSURA(mm)
	805.07.100	F 00R J01 009	1,00
	805.07.101	-	1,01
	805.07.102	-	1,02
	805.07.103	-	1,03
	805.07.104	F 00R J01 010	1,04
	805.07.105	-	1,05
	805.07.106	-	1,06
	805.07.107	-	1,07
	805.07.108	F 00R J01 018	1,08
	805.07.109	-	1,09
	805.07.110	F 00R J01 020	1,10
	805.07.111	-	1,11
	805.07.112	F 00R J01 022	1,12
<b>EMBALAGEM COM 06 PEÇAS</b>			

\* Aplicação em injetores: 0 445 120 092 e 0 445 120 157  
Veículos: Iveco | Case New Holland

13

**CALÇO DO CURSO DO INDUZIDO (AH)**

Ø Interno: 19,60 Ø Externo: 22,80

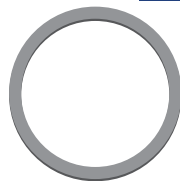

CÓD. ROBIEL	REFERÊNCIA	ESPESSURA(mm)
819.22.150	-	1,50
819.22.151	-	1,51
819.22.152	-	1,52
819.22.153	-	1,53
819.22.154	F 00R J00 883	1,54
819.22.155	-	1,55
819.22.156	F 00R J00 893	1,56
819.22.157	-	1,57
819.22.158	F 00R J00 903	1,58
819.22.159	-	1,59
819.22.160	F 00R J00 913	1,60

**EMBALAGEM COM 06 PEÇAS**

\* Aplicação em injetores: 0 445 120 092 e 0 445 120 157  
Veículos: Iveco | Case New Holland

**TABELA DE INJETORES**

CRIN 2	CRIN 2	CRIN 2	CRIN 2	CRIN 2	CRIN 2	CRIN 3	CRIN 3	CRIN 3	CRIN 3.3
0 445 120 024	0 445 120 078	0 445 120 130	0 445 120 164	0 445 120 222	0 445 120 264	0 445 120 050	0 445 120 184	0 445 120 257	0 445 120 058
0 445 120 026	0 445 120 080	0 445 120 131	0 445 120 165	0 445 120 223	0 445 120 265	0 445 120 071	0 445 120 185	0 445 120 258	0 445 120 095
0 445 120 030	0 445 120 081	0 445 120 134	0 445 120 166	0 445 120 224	0 445 120 266	0 445 120 092	0 445 120 186	0 445 120 259	0 445 120 109
0 445 120 044	0 445 120 083	0 445 120 136	0 445 120 169	0 445 120 225	0 445 120 268	0 445 120 118	0 445 120 187	0 445 120 267	0 445 120 243
0 445 120 045	0 445 120 086	0 445 120 137	0 445 120 170	0 445 120 226	0 445 120 274	0 445 120 135	0 445 120 188	0 445 120 269	C/ CONECTOR
0 445 120 053	0 445 120 087	0 445 120 138	0 445 120 182	0 445 120 227	0 445 120 275	0 445 120 143	0 445 120 193	0 445 120 276	0 445 120 047
0 445 120 054	0 445 120 088	0 445 120 139	0 445 120 183	0 445 120 228	0 445 120 277	0 445 120 157	0 445 120 197	0 445 120 279	0 445 120 048
0 445 120 055	0 445 120 098	0 445 120 141	0 445 120 190	0 445 120 232	0 445 120 278	0 445 120 161	0 445 120 199	0 445 120 281	0 445 120 049
0 445 120 056	0 445 120 099	0 445 120 142	0 445 120 191	0 445 120 234	0 445 120 289	0 445 120 162	0 445 120 201	0 445 120 282	0 445 120 072
0 445 120 057	0 445 120 100	0 445 120 145	0 445 120 192	0 445 120 236	0 445 120 290	0 445 120 167	0 445 120 202	0 445 120 327	0 445 120 073
0 445 120 061	0 445 120 101	0 445 120 146	0 445 120 196	0 445 120 237	0 445 120 291	0 445 120 177	0 445 120 204	C/ CONECTOR	0 445 120 076
0 445 120 062	0 445 120 102	0 445 120 147	0 445 120 200	0 445 120 242	0 445 120 292	0 445 120 178	0 445 120 216	0 445 120 042	0 445 120 090
0 445 120 063	0 445 120 105	0 445 120 148	0 445 120 203	0 445 120 244	0 445 120 293	0 445 120 179	0 445 120 229	0 445 120 082	0 445 120 091
0 445 120 064	0 445 120 106	0 445 120 149	0 445 120 213	0 445 120 245	0 445 120 294	0 445 120 180	0 445 120 233	-	0 445 120 093
0 445 120 065	0 445 120 107	0 445 120 150	0 445 120 215	0 445 120 246	0 445 120 295	0 445 120 181	0 445 120 235	-	0 445 120 126
0 445 120 066	0 445 120 110	0 445 120 153	0 445 120 217	0 445 120 247	C/ CONECTOR	-	-	-	-
0 445 120 067	0 445 120 111	0 445 120 154	0 445 120 218	0 445 120 260	0 445 120 027	-	-	-	-
0 445 120 068	0 445 120 117	0 445 120 155	0 445 120 219	0 445 120 261	-	-	-	-	-
0 445 120 074	0 445 120 124	0 445 120 156	0 445 120 220	0 445 120 262	-	-	-	-	-
0 445 120 075	0 445 120 127	0 445 120 158	0 445 120 221	0 445 120 263	-	-	-	-	-

**415.00.021** KIT DE CALÇOS PARA REPARAÇÃO DE INJETORES CRIN 2 | CRIN 3

Nº	CÓDIGOS	DESCRIÇÃO	ESPESSURAS(mm)	Peças por Medida
AH	819.22.150 - 819.22.160	Calço da Bobina Injetor Iveco Case NH	1,50 à 1,60	12 peças
MFK	802.04.13 - 802.04.165	Calço da Pré-Injeção MWM Cummins	1,30 à 1,70	12 peças
MFP	805.07.100 - 805.07.112	Curso da Esfera do Solenóide Iveco	1,00 à 1,12	12 peças
DFK	803.05.12 - 803.05.16	Calço do Bico Injetor CR   Piezo	1,20 à 1,60	12 peças
DNH	800.02.110 - 800.02.125	Calço Restritor do Bico Injetor CR	1,10 à 1,25	12 peças

**TOTAL DE 576 PEÇAS**



**323.01.3241**

Morsa Giratória para Bancada com Pino Trava

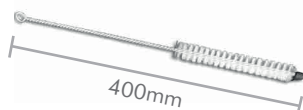

400mm

**323.02.121**

Escova para Limpeza e Remoção de Resíduos Ø 12,00mm



**323.01.841**

Chave da Porca do Bico Injetores Iveco Códigos: 0 445 120 002|092|157|276



**324.15.01**

Suporte de Montagem e Desmontagem de Injetores



**323.02.291**

Ferramenta de Teste da Válvula Bastão Common Rail Injetores CRIN 3



**323.50.063**

Kit de Ferramentas para Reparação de Injetores Bosch CRIN 2|3



# DESCUBRA NOSSOS LANÇAMENTOS



**BAIXE AGORA!**



[WWW.ROBIEL.COM](http://WWW.ROBIEL.COM)

UTILIZE A CÂMERA DO SEU CELULAR PARA ESCANEAR O QR CODE E OBTER MAIS INFORMAÇÕES TÉCNICAS DOS PRODUTOS EM NOSSO APLICATIVO **ROBIEL**

BAIXE NOSSO NOVO APP



## INJETOR CRIN 4.2

FREIGHTLINER | DETROIT DDE 16 15.6L  
DETROIT DDE 15 14.8L | DETROIT DDE13 12.8L

### INJETORES

- 0 445 120 104
- 0 445 120 194
- 0 445 120 195
- 0 445 120 207
- 0 445 120 270
- 0 445 120 271
- 0 445 120 283
- 0 445 120 284
- 0 445 120 285
- 0 445 120 286
- 0 445 120 287
- 0 445 120 288
- 0 445 120 298
- 0 445 120 299
- 0 445 120 300
- 0 445 120 301
- 0 445 120 302
- 0 445 120 303
- 0 445 120 374
- 0 445 120 375
- 0 445 120 385
- 0 445 120 386

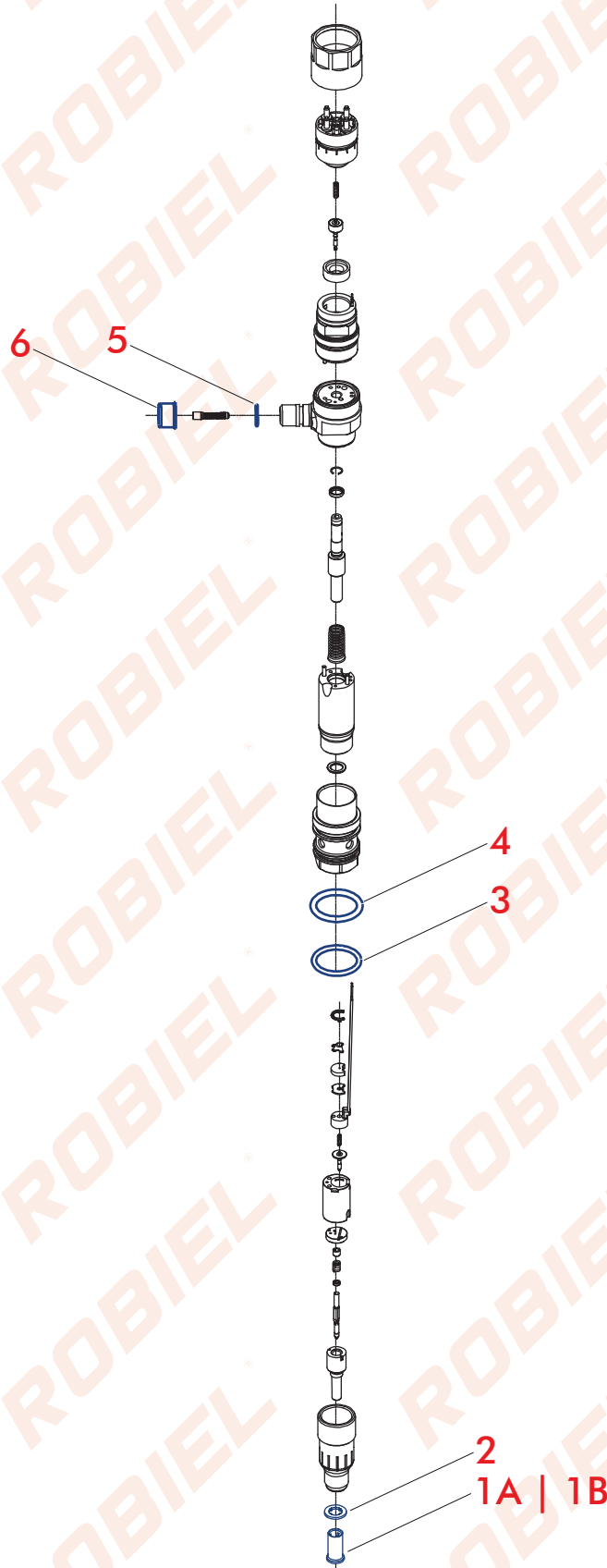

**410.33.337**
**REPARO EXTERNO INJETOR CRIN 4.2**

CÓD. REFERÊNCIA		F 00E 200 337		
Nº	CÓD. ROBIEL	REFERÊNCIA	DESCRIÇÃO	EMB.
1A	220.03.08	F 00R J02 537   F 00R J03 561 6.000.900.262	Capa Protetora	01pç.
2	600.02.01	2 430 105 049	Arruela	01pç.
3	421.30.265	F 00R J01 951	Anel Oring	01pç.
4	421.29.735	F 00R J01 950	Anel Oring	01pç.
5	421.01.320	F 00R J01 947	Anel Oring	01pç.
6	220.03.03	-	Tampa Plástica	01pç.



## PEÇAS AVULSAS

Nº	CÓD. ROBIEL	REFERÊNCIA	DESCRIÇÃO	EMB.
1A	220.03.08	F 00R J02 537   F 00R J03 561 6.000.900.262	Capa Protetora do Bico Injetor Ø 7,00mm	01ct.
1A	220.03.09	F 00H 410 849   F 002 C88 080 6.000.900.076	Capa Protetora do Bico Injetor Ø 9,00mm	01ct.
6	220.03.03	-	Tamp Plástica - Ø Externo 17,00 x Ø Interno 15,00mm	01ct.
2	600.02.01	2 430 105 049	Arruela Perfil Cobre - 7,00 x 15,50 x 1,50mm	01ct.





## SOLUÇÕES PARA SISTEMAS COMMON RAIL

Oferecemos ao segmento diesel diversos produtos para sistemas Common Rail voltados a oficinas e reparadores que buscam melhores alternativas, em comparação as marcas já existentes no mercado, seja em preço ou na qualidade de seus produtos.

Distribuídos no Brasil pela Robiel Injeção Diesel, empresa que atua há mais de 33 anos no setor, nossos produtos proporcionam um excelente custo benefício, tornando o processo de reparação mais simples e ágil, além de oferecer uma maior lucratividade e otimização de processos a seus clientes.

Tendo como objetivos principais a prática de preços acessíveis e uma qualidade similar aos originais, visamos nos tornar referência tanto para oficinais que não possuem a cultura de reparação e remanufatura de componentes de injeção diesel, quanto aos reparadores que se deparam com dificuldades em encontrar produtos com resistência, durabilidade e qualidade no mercado.

### CONJUNTO DE VÁLVULAS

O conjunto de válvula de controle é responsável por micro movimentos de abertura e fechamento de fluxo de combustível em milésimos de segundos e sua resposta tem que ser muito precisa e suportar alta quilometragem.



### PLACAS DE ORIFÍCIO

As placas de orifício são também partes de um sistema de controle de combustível muito preciso, trabalham em conjunto com as válvulas de controle e podem ser substituídas em separado dos bastões.



Estes componentes do sistema common rail são fundamentais para o perfeito funcionamento dos modernos sistemas diesel e garantem o melhor rendimento do combustível, potência do motor e cumprimento das leis de emissões.

**Código Original:** F 00R J00 005

**B01.04.0005**

<b>Número do Injetor</b>	O 986 435 501	<b>Motor</b>	2.8 JTD
	O 445 120 002		

<b>Aplicações</b>	Ducato / Jumper / Boxer	2005 - 2009
-------------------	-------------------------	-------------

**Código Original:** F 00R J00 339

**B01.04.0339**

<b>Número do Injetor</b>	O 445 120 007	<b>Motor</b>	ISBe4 ISB6 - F4A
--------------------------	---------------	--------------	------------------

<b>Aplicações</b>	Agrale MA e MT12	01/2005 - 12/2009
	Iveco 170E25 e 240E25 e 170E22	12/2008 - 04/2012
	Eurocargo 170E22	01/2005
	Eurocargo 230E22	03/2006 - 12/2009
	Eurocargo 230E24	03/2006 - 12/2011
	New Holland T7060	10/2007 - 12/2014

**Código Original:** F 00V C01 022

**B01.04.1022**

<b>Número do Injetor</b>	O 445 110 141	<b>Motor</b>	G9U - 2.5 16V
--------------------------	---------------	--------------	---------------

<b>Aplicações</b>	Renault Master - Euro 3	2005 - 2011
-------------------	-------------------------	-------------

**Código Original:** F 00V C01 023

**B01.04.1023**

<b>Número do Injetor</b>	O 445 110 231	<b>Motor</b>	MWM 4.07 TCE - SPRINT EURO 3
--------------------------	---------------	--------------	------------------------------

<b>Aplicações</b>	VW-Delivery 5.140/8.150	10/2005 - 12/2011
	Chevrolet S10	08/2005 - 01/2012
	Chevrolet Blazer	08/2005 - 05/2009

**Código Original:** F 00V C01 051

**B01.04.1051**

<b>Número do Injetor</b>	O 445 110 190	<b>Motor</b>	OM612 LA CDI 2.2 16V - 4 CIL. OM612 LA CDI 2.7 20V - 5 CIL.
--------------------------	---------------	--------------	--

<b>Aplicações</b>	MBB - Sprinter 311/313/413 - Euro 3	2002 - 2011
	MBB - Accelo 715 - Euro 3	2002 - 2011
	Gran Cherokee - 2.7 20V	2002 - 2004

**Código Original:** F 00R J01 278

**B01.04.1278**

<b>Número do Injetor</b>	O 445 120 054	<b>Motor</b>	NEF 4 / NEF 6
--------------------------	---------------	--------------	---------------

<b>Aplicações</b>	Iveco Tector 170E22/170E28/240E22/240E28/260E28	05/2012
	Vertis 90V16 / 130V18	10/2010 - 09/2012
	130V19 / 90V18	10/2012
	Case 2855491 / IH 2855491	



**B01.04.1379**
**Código Original: F 00V C01 379**

<b>Número do Injetor</b>	O 445 110 424	<b>Motor</b>	2.8 CTDI
<b>Aplicações</b>	Chevrolet - S10 / Trail Blazer		2012 - 2013

**B01.04.1383**
**Código Original: F 00V C01 383**

<b>Número do Injetor</b>	O 445 110 376	<b>Motor</b>	ISF 2.8 - Euro 5 - 150CV
<b>Aplicações</b>	Cummins F350/F4000		12/2014

**B01.04.1338**
**Código Original: F 00V C01 338**

<b>Número do Injetor</b>	O 445 110 248	<b>Motor</b>	F1CE0481 - 3.0 - Euro 3
	O 445 110 273		F1AE0481T - 2.3 - Euro 3
<b>Aplicações</b>	Iveco Daily 3.0 - City Class / Daily 35S14 / 40S16 / 45S14 / 45S16 / 55S16		08/2007 - 03/2012
	Scudato 70C16		
	Ducato / Jumper / Boxer		10/2009 - 02/2012

**B01.04.1895**
**Código Original: F 00R J01 895**

<b>Número do Injetor</b>	O 445 120 016	<b>Motor</b>	MWM 4.12
	O 445 120 017		6.12 TCE
<b>Aplicações</b>	VW 15.190		2004 - 2012
	VW 17.230		

**B01.04.1941**
**Código Original: F 00R J01 941**

<b>Número do Injetor</b>	O 445 120 120	<b>Motor</b>	ISC 8.3
	O 445 120 140		
<b>Aplicações</b>	VW 18.320EOT		02/2006 - 12/2011
	Constellation 19.320 Titan		10/2005 - 12/2011
	Constellation 25.320		03/2008 - 08/2011
	Constellation 31.320		01/2007 - 12/2011
	Ford Cargo 28/40/43 e 5332		

**B01.04.2103**
**Código Original: F 00R J02 103**

<b>Número do Injetor</b>	O 445 120 186	<b>Motor</b>	ISF 3.8
	O 445 120 162		
	O 445 120 134		
<b>Aplicações</b>	VW 5.150 / 8.160 / 9.160 Foton		2012 ->

**Código Original: F 00R J02 130**
**B01.04.2130**

<b>Número do Injetor</b>	O 445 120 212	<b>Motor</b>	ISB4 / ISB6 / F4A
<b>Aplicações</b>	VW 8150 / 24250 / 23250		2004 - 2011
	Ford 1317e / 1717e / 2422e / 2428e		2004 - 2011
	Agrale MT 12.0e		2004 - 2011
	Iveco Tector 170E22		2004 - 2011
	Eurocargo 170E22 / 230E22 / 230E24		2004 - 2011
	New Holland T7060		2004 - 2011

**Código Original: F 00R J02 449**
**B01.04.2449**

<b>Número do Injetor</b>	O 445 120 186 O 445 120 162 O 445 120 134	<b>Motor</b>	D0834
<b>Aplicações</b>	VW Constellation 13/15.190		2012 ->

**Código Original: F 00R J02 506**
**B01.04.2506**

<b>Número do Injetor</b>	O 445 120 106 O 445 120 199 O 445 120 257 O 445 120 310	<b>Motor</b>	ISC 8.3 I e ISL
<b>Aplicações</b>	Cargo 1832		01/2010 - 12/2011
	Cargo 1932		04/2011
	2632/2932/3132/4432/4532/ Max ton 5032/ 6332		02/2006 - 12/2011
	VW 18.320 EOT		02/2007 - 12/2011
	Constellation 17.320/19.320/24.320/25.320.31.320		02/2007 - 12/2011





**410.00.062**

**REPARO DO INJETOR CATERPILLAR/PERKINS**

CÓD. REFERÊNCIA				
Nº	CÓD. ROBIEL	REFERÊNCIA	DESCRIÇÃO	EMB.
1	623.26.10	-	Arruela	01pç.
2	421.01.426	-	Anel	01pç.
3	421.02.417	-	Anel	01pç.



**PEÇAS AVULSAS**

Nº	CÓD. ROBIEL	REFERÊNCIA	DESCRIÇÃO	EMB.
4A	607.14.20	MN155904	Arruela do Bico Injetor Caterpillar 7,00 X 13,70 X 2,00	48pç.
4B	607.14.10	-	Arruela do Bico Injetor Caterpillar 7,00 X 13,70 X 1,00	48pç.
5	VC6.10.0062	32F61-00062	Válvula de Controle Caterpillar 320D	01pç.
9A	220.03.08	F 00R J02 537   F 00R J03 561 6.000.900.262	Capa Protetora do Bico Injetor Ø 7,00mm	01ct.
9B	220.03.09	F 00H 410 849   F 002 C88 080 6.000.900.076	Capa Protetora do Bico Injetor Ø 9,00mm	01ct.

**4A**  Espessura: 2,00 mm



**4B**  Espessura: 1,00 mm



**5** 



**9A** 



**9B** 





**6 CALÇO DA BOBINA DO INJETOR CATERPILLAR** 

Ø Externo: 6,60mm

CÓD. ROBIEL	REFERÊNCIA	ESPESSURA(mm)
800.07.218	-	2,18
800.07.220	-	2,20
800.07.222	-	2,22
800.07.224	-	2,24
800.07.226	-	2,26
800.07.228	-	2,28
800.07.230	-	2,30
800.07.232	-	2,32

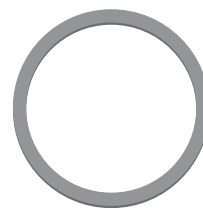
**EMBALAGEM COM 8 PEÇAS**



**7 CALÇO DA INDUTÂNCIA DO INJETOR CATERPILLAR** 

22,5 x 26,0mm

CÓD. ROBIEL	REFERÊNCIA	ESPESSURA(mm)
822.26.228	-	2,28
822.26.230	-	2,30
822.26.232	-	2,32
822.26.234	-	2,34
822.26.236	-	2,36
822.26.238	-	2,38

**EMBALAGEM COM 8 PEÇAS**

8A	CALÇO DO BICO INJETOR CATERPILLAR AGULHA ALTA		
	INOX - Ø Externo: 6,60mm		
	CÓD. ROBIEL	REFERÊNCIA	ESPESSURA(mm)
	800.07.140	-	1,40
	800.07.142	-	1,42
	800.07.144	-	1,44
	800.07.146	-	1,46
	800.07.148	-	1,48
	800.07.150	-	1,50
	800.07.152	-	1,52
	800.07.154	-	1,54
	800.07.156	-	1,56
	800.07.158	-	1,58
	800.07.160	-	1,60
<b>EMBALAGEM COM 8 PEÇAS</b>			

8B	CALÇO DO BICO INJETOR CATERPILLAR AGULHA BAIXA		
	INOX - Ø Externo: 6,60mm		
	CÓD. ROBIEL	REFERÊNCIA	ESPESSURA(mm)
	800.07.206	-	2,06
	800.07.208	-	2,08
	800.07.210	-	2,10
	800.07.212	-	2,12
	800.07.214	-	2,14
	800.07.216	-	2,16
<b>EMBALAGEM COM 8 PEÇAS</b>			

<b>415.01.01</b> KIT DE CALÇOS PARA REPARAÇÃO DE INJETORES E BOMBAS CATERPILLAR C4   C6			
CÓDIGOS	DESCRIÇÃO	ESPESSURAS(mm)	Peças por Medida
800.07.140 - 800.07.230	Calço do Bico/Bobina do Injetor	1,40 à 2,30	12 peças
822.26.228 - 822.26.238	Calço da Indutância do Injetor	2,28 à 2,38	12 peças
803.07.125 - 803.07.15	Calço de Ajuste do solenoide da BBA	1,25 à 1,50	12 peças
803.09.165 - 803.09.20	Calço de Ajuste da bobina da BBA	1,65 à 2,00	12 peças
<b>TOTAL DE 528 PEÇAS</b>			





CONSULTE OS PRODUTOS DE  
MANEIRA **RÁPIDA E PRÁTICA**



SOLICITE SEU **ORÇAMENTO**  
SEM SAIR DO APP



FIQUE POR DENTRO DE  
NOSSOS **LANÇAMENTOS**



ENCONTRE O PRODUTO QUE  
ESTAVA PROCURANDO ATRAVÉS  
DA **CÂMERA DO SEU CELULAR**

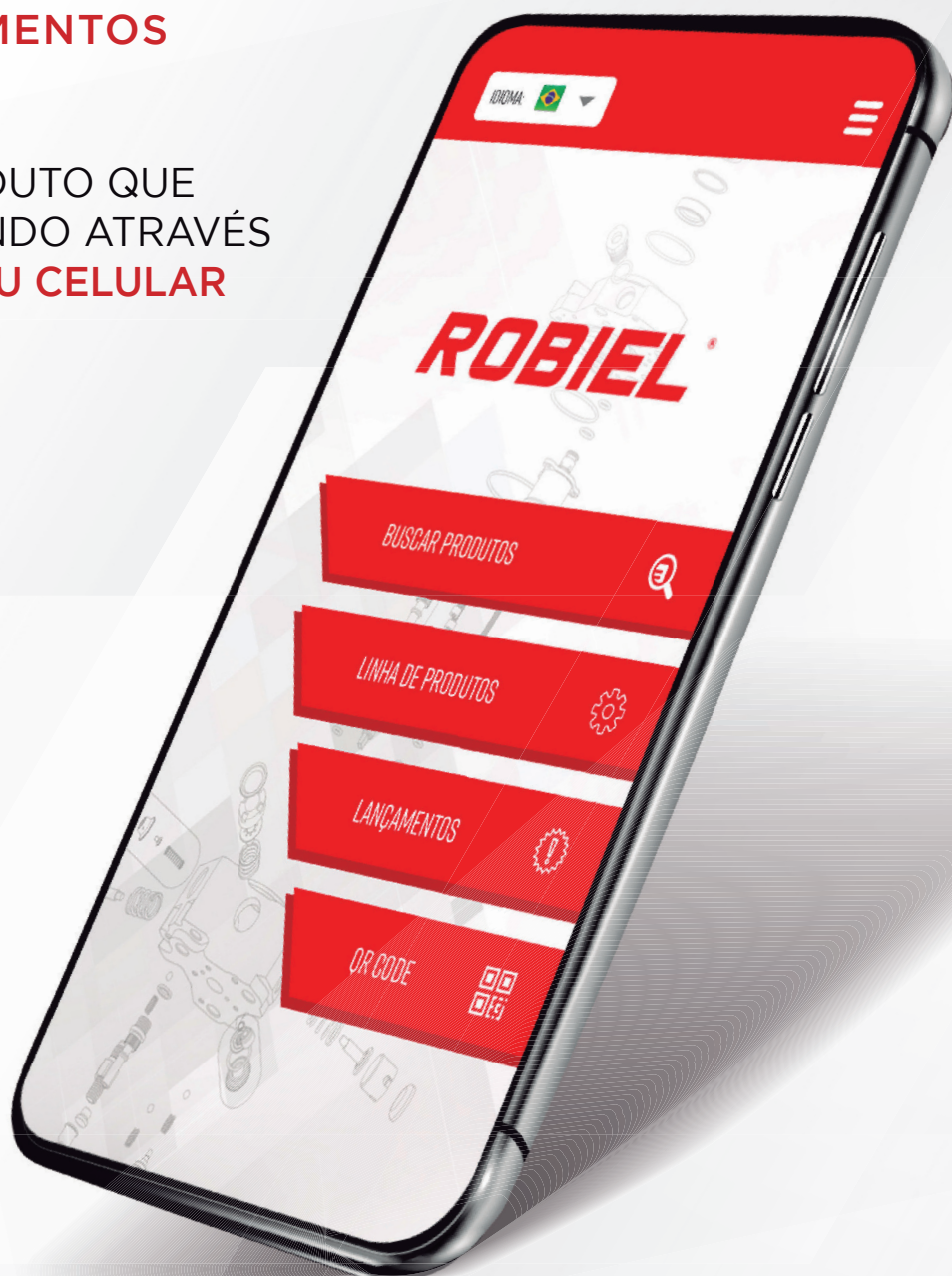

E VOCÊ, JÁ BAIXOU O  
APLICATIVO **ROBIEL**?

**BAIXE AGORA!**

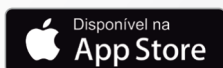

WWW.ROBIEL.COM

UTILIZE A CÂMERA DO SEU CELULAR PARA ESCANEAR O QR CODE E OBTER MAIS **INFORMAÇÕES TÉCNICAS** DOS PRODUTOS EM NOSSO APLICATIVO **ROBIEL**

BAIXE NOSSO NOVO APP



## INJETOR CUMMINS XPI

SCANIA D9 XPI | D13 XPI | D16 XPI  
DC13 XPI CUMMINS ISX 15

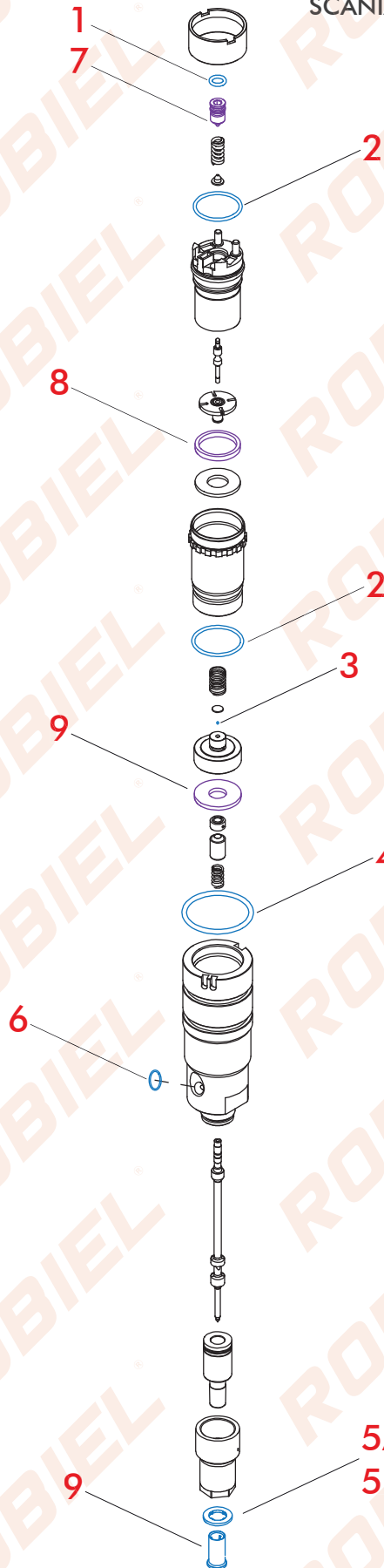

### INJETORES

1881564

2031836

2086663

2872405



410.32.211 REPARO INJETOR CUMMINS ISX 15 XPI - COMPLETO				
CÓD. REFERÊNCIA		1932820   1933246		
Nº	CÓD. ROBIEL	REFERÊNCIA	DESCRIÇÃO	EMB.
1	421.06.178	-	Anel Oring	01pç.
2	421.23.518	-	Anel Oring	01pç.
3	190.52.01	-	Esfera Cerâmica	01pç.
4	421.35.626	-	Anel Oring	01pç.
5A	609.16.15	-	Arruela de Cobre	01pç.
6	421.12.262	-	Anel Oring	01pç.





410.32.212 REPARO INJETOR CUMMINS ISX 15 XPI - COMPLETO				
CÓD. REFERÊNCIA				
Nº	CÓD. ROBIEL	REFERÊNCIA	DESCRIÇÃO	EMB.
1	421.06.178	-	Anel Oring	01pç.
2	421.23.518	-	Anel Oring	01pç.
3	190.52.01	-	Esfera Cerâmica	01pç.
4	421.35.626	-	Anel Oring	01pç.
5B	600.03.05	-	Luva de vedação	01pç.
6	421.12.262	-	Anel Oring	01pç.
9	220.03.09	F 00H 410 849   F 002 C88 080 6.000.900.076	Capa Protetora	01pç.





410.32.820 REPARO EXTERNO INJETOR CUMMINS ISX 15 XPI				
CÓD. REFERÊNCIA		1932820		
Nº	CÓD. ROBIEL	REFERÊNCIA	DESCRIÇÃO	EMB.
4	421.35.626	-	Anel Oring	01pç.
5	609.16.15	-	Arruela de Cobre	01pç.
6	421.12.262	-	Anel Oring	01pç.





410.32.236 REPARO DE FILTROS INJETOR CUMMINS ISX - SCANIA 470				
CÓD. REFERÊNCIA				
CÓD. ROBIEL	REFERÊNCIA	DESCRIÇÃO	EMB.	
200.01.06	-	Filtro de Alimentação	01pç.	
200.01.07	-	Filtro de Retorno	01pç.	



7	BUJAO INJETOR SCANIA XPI CUMMINS ISX15 / ISL / FOTON		
	CÓD. ROBIEL	REFERÊNCIA	ESPESSURA(mm)
	165.07.620	-	6,20
	165.07.630	-	6,30
	165.07.640	-	6,40
	165.07.650	-	6,50
	165.07.660	-	6,60
EMBALAGEM COM 01 PEÇA			

9	CALÇO DO bico XPI   ISX		
	CÓD. ROBIEL	REFERÊNCIA	ESPESSURA(mm)
	810.26.210	-	2,10
	810.26.212	-	2,12
	810.26.214	-	2,14
	810.26.216	-	2,16
	810.26.218	-	2,18
	810.26.220	-	2,20
	810.26.222	-	2,22
	810.26.224	-	2,24
	810.26.226	-	2,26
	810.26.228	-	2,28
	810.26.230	-	2,30
	810.26.232	-	2,32
	810.26.234	-	2,34
	810.26.236	-	2,36
	810.26.238	-	2,38
	810.26.240	-	2,40
EMBALAGEM COM 6 PEÇAS			

8	CALÇO DO SOLENOIDE XPI   ISX   ISL   FOTON		
	CÓD. ROBIEL	REFERÊNCIA	ESPESSURA(mm)
	821.82.290	-	2,90
	821.82.292	-	2,92
	821.82.294	-	2,94
	821.82.296	-	2,96
	821.82.298	-	2,98
	821.82.300	-	3,00
	821.82.302	-	3,02
	821.82.304	-	3,04
	821.82.306	-	3,06
	821.82.308	-	3,08
	821.82.310	-	3,10
	821.82.312	-	3,12
	821.82.314	-	3,14
	821.82.316	-	3,16
	821.82.318	-	3,18
	821.82.320	-	3,20
EMBALAGEM COM 6 PEÇAS			



**323.50.38**

Kit de Reparação para Injetores Scania | Cummins XPI | ISX 15 | ISL | Foton



**323.01.324**

Morsa Giratória para Bancada com Pino Trava



**324.15.01**

Suporte de Montagem e Desmontagem de Injetores



# APLICATIVO **ROBIEL**<sup>®</sup>

INÚMEROS RECURSOS PARA OTIMIZAR  
A ROTINA DA SUA **OFICINA!**



ESCANEE O QR CODE PARA  
REALIZAR O DOWNLOAD  
DO APLICATIVO ROBIEL!

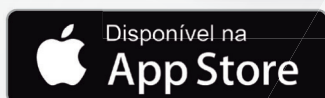

[WWW.ROBIEL.COM](http://WWW.ROBIEL.COM)

UTILIZE A CÂMERA DO SEU CELULAR PARA ESCANEAR O QR CODE E OBTER MAIS INFORMAÇÕES TÉCNICAS DOS PRODUTOS EM NOSSO APLICATIVO **ROBIEL**

BAIXE NOSSO NOVO APP



## INJETOR CUMMINS ISL

SCANIA

### INJETORES

2872127

4954927

4984332

4954679

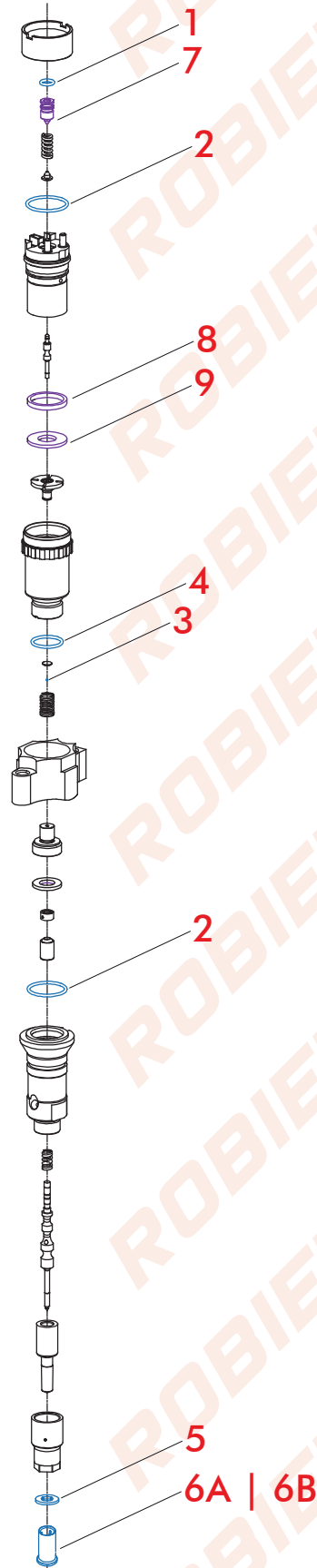

**410.32.127**

**REPARO INJETOR CUMMINS ISC/ISL/QLS/QSC - COMPLETO**

CÓD. REFERÊNCIA				
Nº	CÓD. ROBIEL	REFERÊNCIA	DESCRIÇÃO	EMB.
1	421.06.178	-	Anel Oring	01 pç.
2	421.23.518	-	Anel Oring	01 pç.
3	190.52.01	-	Esfera Cerâmica	01 pç.
4	421.01.717	-	Anel Oring	01 pç.
5	600.02.07	F 00V C17 503	Arruela de Cobre	01 pç.
6A	220.03.08	F 00R J02 537   F 00R J03 561 6.000.900.262	Tampa Protetora	01 pç.

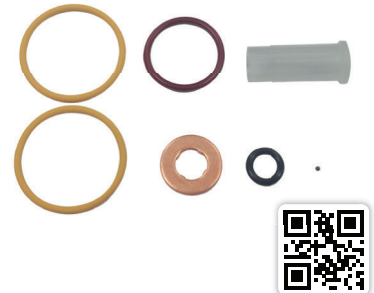

**PEÇAS AVULSAS**

Nº	CÓD. ROBIEL	REFERÊNCIA	DESCRIÇÃO	EMB.
5	600.02.07	F 00V C17 503	Arruela do Porta Injetor Cummins	24 pç.
6A	220.03.08	F 00R J02 537   F 00R J03 561 6.000.900.262	Tampa Protetora para Bico Injetor Ø7,00mm	01 ct.
6B	220.03.09	F 00H 410 849   F 002 C88 080 6.000.900.076	Tampa Protetora para Bico Injetor Ø9,00mm	01 ct.



7	BUJAO INJETOR SCANIA XPI CUMMINS ISX15 / ISL / FOTON		
	CÓD. ROBIEL	REFERÊNCIA	ESPESSURA(mm)
	165.07.620	-	6,20
	165.07.630	-	6,30
	165.07.640	-	6,40
	165.07.650	-	6,50
	165.07.660	-	6,60

EMBALAGEM COM 01 PEÇA

8	CALÇO DO SOLENOIDE XPI   ISX   ISL   FOTON		
	CÓD. ROBIEL	REFERÊNCIA	ESPESSURA(mm)
	821.82.290	-	2,90
	821.82.292	-	2,92
	821.82.294	-	2,94
	821.82.296	-	2,96
	821.82.298	-	2,98
	821.82.300	-	3,00
	821.82.302	-	3,02
	821.82.304	-	3,04
	821.82.306	-	3,06
	821.82.308	-	3,08
	821.82.310	-	3,10
	821.82.312	-	3,12
	821.82.314	-	3,14
	821.82.316	-	3,16
	821.82.318	-	3,18
	821.82.320	-	3,20

EMBALAGEM COM 6 PEÇAS

9	CALÇO DO BICO ISL   FOTON		
	CÓD. ROBIEL	REFERÊNCIA	ESPESSURA(mm)
	818.91.0190	-	1,90
	818.91.0192	-	1,92
	818.91.0194	-	1,94
	818.91.0196	-	1,96
	818.91.0198	-	1,98
	818.91.0200	-	2,00
	818.91.0202	-	2,02
	818.91.0204	-	2,04
	818.91.0206	-	2,06
	818.91.0208	-	2,08
	818.91.0210	-	2,10
	818.91.0212	-	2,12
	818.91.0214	-	2,14
	818.91.0216	-	2,16
	818.91.0218	-	2,18
	818.91.0220	-	2,20

EMBALAGEM COM 6 PEÇAS



**323.50.38**

Kit de Reparação para Injetores Scania | Cummins XPI | ISX 15 | ISL | Foton





410.12.900		REPARO INJETOR DAF MX13		
CÓD. REFERÊNCIA		182-5900   213-5457		
Nº	CÓD. ROBIEL	REFERÊNCIA	DESCRIÇÃO	EMB.
1	421.01.220	-	Anel Oring	01pç.
2A	421.27.200	182-5900	Anel Oring	01pç.
2B	421.27.250	213-5457	Anel Oring	01pç.
3	421.24.250	-	Anel Oring	01pç.
4	807.16.20	-	Arruela	01pç.
5A	220.03.08	-	Tampa Protetora	01pç.



## PEÇAS AVULSAS

Nº	CÓD. ROBIEL	REFERÊNCIA	DESCRIÇÃO	EMB.
5A	220.03.08	F 00R J02 537   F 00R J03 561 6.000.900.262	Tampa Protetora para Bico Injetor Ø7,00mm	01ct.
5B	220.03.09	F 00H 410 849   F 002 C88 080 6.000.900.076	Tampa Protetora para Bico Injetor Ø9,00mm	01ct.



## EM BREVE

**323.50.41**

 Kit de Reparação Injetor e  
Unidade Bombeadora DAF

**323.01.3241**

 Morsa Giratória para Bancada  
com Pino Trava

**324.15.01**

 Suporte de Montagem e  
Desmontagem de Unidades

UTILIZE A CÂMERA DO SEU CELULAR PARA ESCANEAR O QR CODE E OBTER MAIS INFORMAÇÕES TÉCNICAS DOS PRODUTOS EM NOSSO APLICATIVO **ROBIEL**

BAIXE NOSSO NOVO APP

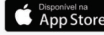

## INJETOR DELPHI

HR  
H100  
Sprinter  
Kia Bongo

Nº INJETOR

28229873

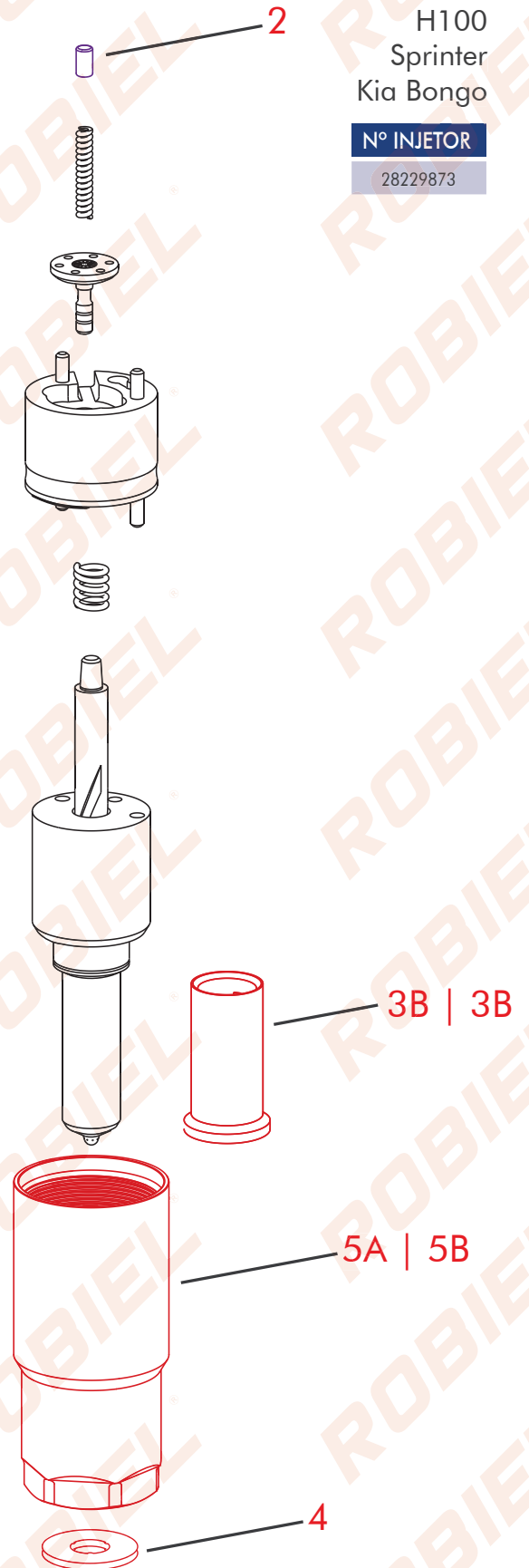
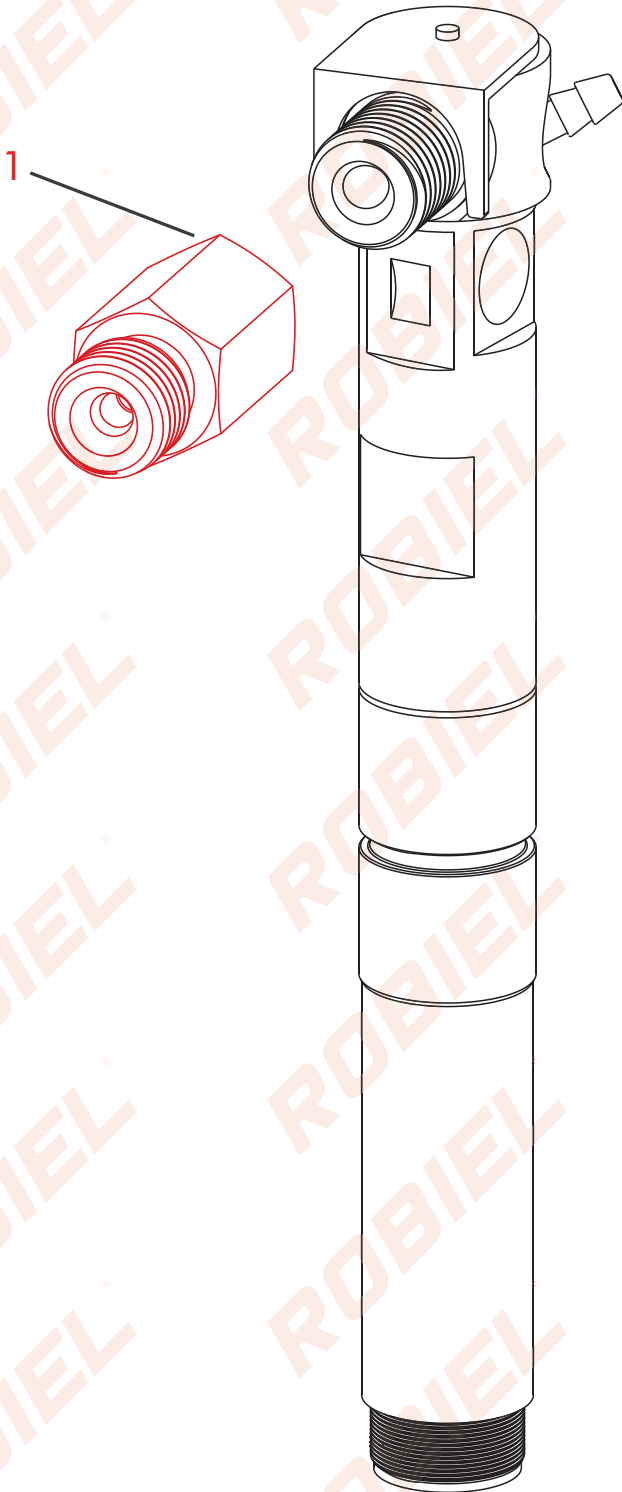

**PEÇAS AVULSAS**

Nº	CÓD. ROBIEL	REFERÊNCIA	DESCRIÇÃO	EMB.
<b>1</b>	165.02.15	Injetores c/ Caneta	Conexão com Microfiltro CR Delphi   Bosch - M14x1,50mm	<b>01pc.</b>
<b>3A</b>	220.03.08	F 00R J02 537   F 00R J03 561 6.000.900.262	Capa Protetora do Bico Injetor Ø 7,00mm	<b>01ct.</b>
<b>3B</b>	220.03.09	F 00H 410 849   F 002 C88 080 6.000.900.076	Capa Protetora do Bico Injetor Ø 9,00mm	<b>01ct.</b>
<b>4</b>	607.14.20	MN155904	Arruela do Bico Injetor 7,00 X 13,70 X 2,00	<b>48pc.</b>
<b>5A</b>	315.06.59	28229873	Capa do Bico Injetor Common Rail Delphi - Kia Bongo	<b>01pc.</b>
<b>5B</b>	315.06.63	-	Capa do Bico Injetor Common Rail Delphi - MBB Sprinter	<b>01pc.</b>

**1**



Rosca: M14 X 1,50mm  
Aplicada em Injetores  
com Caneta/Bastão

**3A**



**3B**



**4**



Esperrura: 2,00 mm

**5A**



**5B**



**2** CALÇO DE REGULAGEM DE DEBITO DO INJETOR DELPHI  
Ø Externo: 2,00

CÓD. ROBIEL	APLICAÇÃO	ESPESSURA(mm)
800.20.5260	HR   SPRINTER	2,60
800.20.5265	HR   SPRINTER	2,65
800.20.5270	HR   SPRINTER	2,70
800.20.5275	HR   SPRINTER	2,75
800.20.5280	HR   SPRINTER	2,80
800.20.5285	HR   SPRINTER	2,85
800.20.5290	HR   SPRINTER	2,90
800.20.5295	HR   SPRINTER	2,95
800.20.5300	HR   SPRINTER	3,00

EMBALAGEM COM 06 PEÇAS

UTILIZE A CÂMERA DO SEU CELULAR PARA ESCANEAR O QR CODE E OBTER MAIS **INFORMAÇÕES TÉCNICAS** DOS PRODUTOS EM NOSSO APLICATIVO **ROBIEL**

BAIXE NOSSO NOVO APP



## INJETOR DELPHI

JCB  
Ssangyong Action

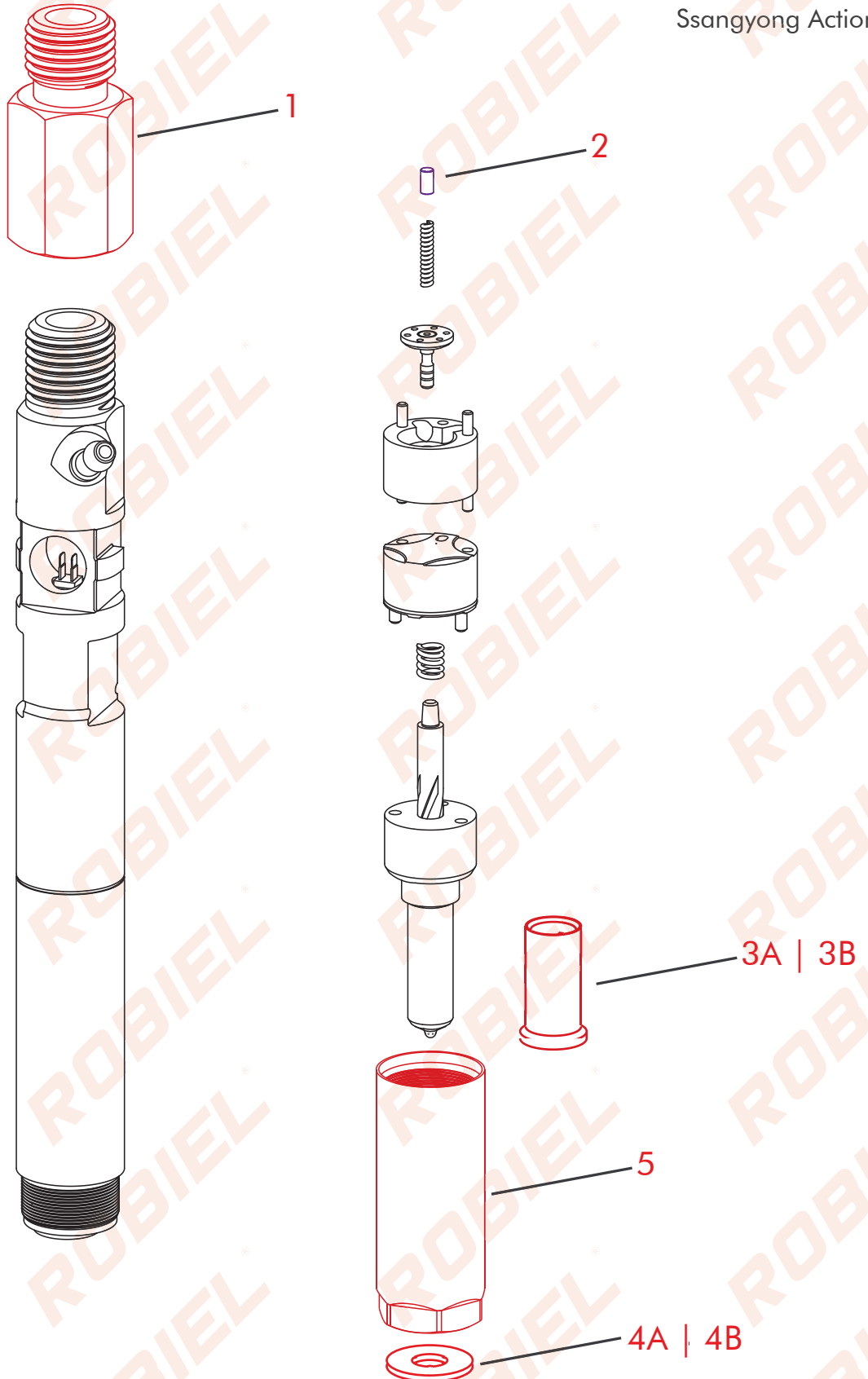

**PEÇAS AVULSAS**

Nº	CÓD. ROBIEL	REFERÊNCIA	DESCRIÇÃO	EMB.
<b>1</b>	165.02.15	Injetores c/ Caneta	Conexão com Microfiltro CR Delphi   Bosch - M14x1,50mm	<b>01pç.</b>
<b>3A</b>	220.03.08	F 00R J02 537   F 00R J03 561 6.000.900.262	Capa Protetora do Bico Injetor Ø 7,00mm	<b>01ct.</b>
<b>3B</b>	220.03.09	F 00H 410 849   F 002 C88 080 6.000.900.076	Capa Protetora do Bico Injetor Ø 9,00mm	<b>01ct.</b>
<b>4A</b>	600.02.07	F 00V C17 503 F 00R J01 453	Arruela do Porta Injetor Common Rail Cummins - 1,50mm	<b>24pç.</b>
<b>4B</b>	600.02.08	F 00V C17 505 F 00R J01 086	Arruela do Porta Injetor Common Rail MWM - 2,00mm	<b>24pç.</b>
<b>5</b>	315.06.60	-	Porca do Bico Injetor Delphi - JCB / Ssangyong	<b>01pç.</b>

**2**
**CALÇO DE REGULAGEM DE DEBITO  
DO INJETOR DELPHI**

Ø Externo: 2,00



CÓD. ROBIEL	REFERÊNCIA	ESPESSURA(mm)
800.20.5360	-	3,60
800.20.5365	-	3,65
800.20.5370	-	3,70
800.20.5375	-	3,75
800.20.5380	-	3,80
800.20.5385	-	3,85
800.20.5390	-	3,90
800.20.5395	-	3,95
800.20.5400	-	4,00

EMBALAGEM COM 06 PEÇAS

UTILIZE A CÂMERA DO SEU CELULAR PARA ESCANEAR O QR CODE E OBTER MAIS INFORMAÇÕES TÉCNICAS DOS PRODUTOS EM NOSSO APLICATIVO **ROBIEL**

BAIXE NOSSO NOVO APP



## INJETORES DENSO G2

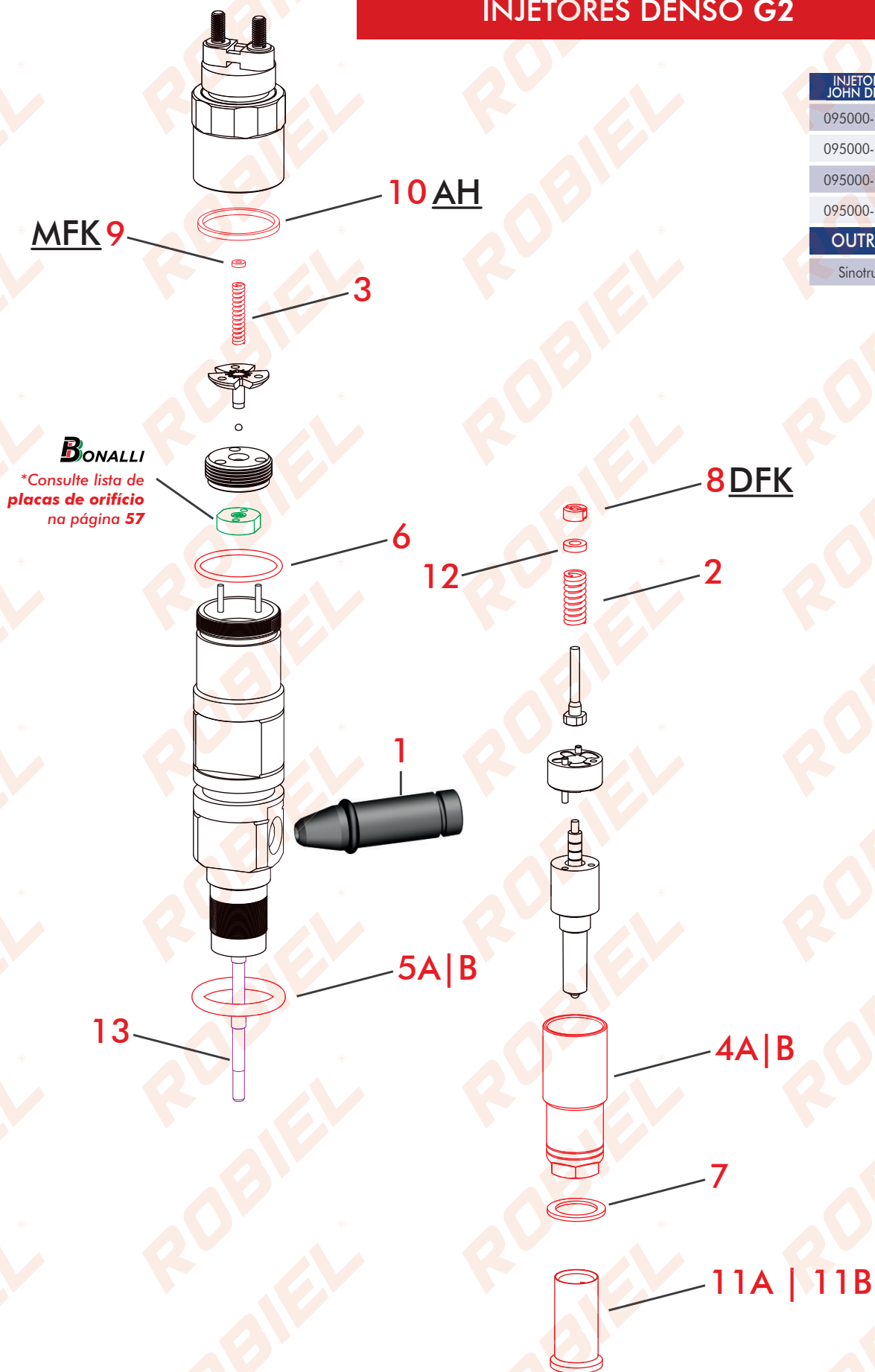

INJETORES JOHN DEERE
095000-5190
095000-6480
095000-6481
095000-6482
OUTROS
Sinotruck

<b>410.70.461</b>				<b>REPARO INJETOR JOHN DEERE 9.0L - S4</b>	
CÓD. REFERÊNCIA		095000-6460			
CÓD. ROBIEL	REFERÊNCIA	DESCRIÇÃO	EMB.		
421.00.926	-	Anel Oring	01 pç.		
421.02.035	-	Anel Oring	01 pç.		
421.02.318	-	Anel Oring	01 pç.		
807.13.20	-	Arruela	01 pç.		
220.03.08	-	Capa Protetora	01 pç.		

<b>410.70.151</b>				<b>REPARO INJETOR JOHN DEERE 8.1L - HPCR</b>	
CÓD. REFERÊNCIA		095000-5150   095000-7560   RE524361   RE518726   SE501936   RE501010			
CÓD. ROBIEL	REFERÊNCIA	DESCRIÇÃO	EMB.		
421.00.926	-	Anel Oring	01 pç.		
421.02.020	-	Anel Oring	01 pç.		
421.02.318	-	Anel Oring	01 pç.		
807.13.20	-	Arruela	01 pç.		
220.03.08	-	Capa Protetora	01 pç.		

## PEÇAS AVULSAS

Nº	CÓD. ROBIEL	REFERÊNCIA	DESCRIÇÃO	EMB.
<b>1</b>	165.03.06	-	Conexão de Entrada do Injetor Denso John Deere	01 pç.
<b>2</b>	225.01.38	-	Mola do Bico Injetor Denso John Deere	06 pç.
<b>3</b>	225.01.39	-	Mola do Solenóide do Injetor Denso John Deere	06 pç.
<b>4A</b>	315.06.54	-	Porca do Bico Injetor 095000-5190	04 pç.
<b>4B</b>	315.06.34	-	Porca do Bico Injetores 095000-6480   6481   6482	06 pç.
<b>5A</b>	421.02.020	-	Anel do Injetor 095000-5190	12 pç.
<b>5B</b>	421.02.035	-	Anel dos Injetores 095000-6480   6481   6482	06 pç.
<b>6</b>	421.02.318	-	Anel do Solenóide do Injetor Denso John Deere	12 pç.
<b>7</b>	807.13.20	-	Arruela do Bico Injetor Denso	48 pç.
<b>11A</b>	220.03.08	F 00R J02 537   F 00R J03 561 6.000.900.262	Capa Protetora do Bico Injetor Ø 7,00mm	01 ct.
<b>11B</b>	220.03.09	F 00H 410 849   F 002 C88 080 6.000.900.076	Capa Protetora do Bico Injetor Ø 9,00mm	01 ct.

**1**

**2**

**3**

**4A**

**4B**

**5A**

**5B**

**6**

**7**

**11A**

**11B**

Ø INT: 7,00mm  
 Ø EXT: 13,00mm  
 ESP: 2,00mm

**8**
**CALÇO DA FORÇA DA MOLA DO BICO INJETOR (DFK)**

CÓD. ROBIEL	REFERÊNCIA	ESPESSURA(mm)
800.00.290	-	2,90
800.00.295	-	2,95
800.00.300	-	3,00
800.00.305	-	3,05
800.00.310	-	3,10

**EMBALAGEM COM 12 PEÇAS**
**9**
**CALÇO DA FORÇA DA MOLA DA BOBINA (MFK)**

Ø Interno: 1,80 Ø Externo: 4,00



CÓD. ROBIEL	REFERÊNCIA	ESPESSURA(mm)
801.04.12	-	1,20
801.04.125	-	1,25
801.04.13	-	1,30
801.04.135	-	1,35
801.04.14	-	1,40
801.04.145	-	1,45
801.04.15	-	1,50

**EMBALAGEM COM 06 PEÇAS**
**10**
**CALÇO DE AJUSTE DO CURSO DA INDUTÂNCIA (AH)**

Ø Interno: 21,40 Ø Externo: 24,30



CÓD. ROBIEL	ESPESSURA(mm)	CÓD. ROBIEL	ESPESSURA(mm)
821.24.150	1,50	821.24.161	1,61
821.24.151	1,51	821.24.162	1,62
821.24.152	1,52	821.24.163	1,63
821.24.153	1,53	821.24.164	1,64
821.24.154	1,54	821.24.165	1,65
821.24.155	1,55	821.24.166	1,66
821.24.156	1,56	821.24.167	1,67
821.24.157	1,57	821.24.168	1,68
821.24.158	1,58	821.24.169	1,69
821.24.159	1,59	821.24.170	1,70
821.24.160	1,60	<b>EMBALAGEM COM 10 PEÇAS</b>	

**12**
**CALÇO DA MOLA DO INJETOR DENSO**

Ø Interno: 3,50 Ø Externo: 6,75



CÓD. ROBIEL	ESPESSURA(mm)
804.06.130	1,30
804.06.135	1,35
804.06.140	1,40
804.06.145	1,45
804.06.150	1,50
804.06.155	1,55
804.06.160	1,60
804.06.165	1,65
804.06.170	1,70

**EMBALAGEM COM 06 PEÇAS**

**13** **BASTÃO DO INJETORES DENSO**  
**5160**  
 Comprimento 79,20mm

CÓD. ROBIEL	REFERÊNCIA	ESPESSURA(mm)
BID.01.4300	-	4,300
BID.01.4305	-	4,305

EMBALAGEM COM 01 PEÇA

**13** **BASTÃO DO INJETORES DENSO**  
**6490**  
 Comprimento 66,70mm

CÓD. ROBIEL	REFERÊNCIA	ESPESSURA(mm)
BID.02.4300	-	4,300
BID.02.4302	-	4,302
BID.02.4305	-	4,305

EMBALAGEM COM 01 PEÇA

**13** **BASTÃO DO INJETORES DENSO**  
**23670-0L020 (HILUX 3.0)**  
 Comprimento 117,70mm

CÓD. ROBIEL	REFERÊNCIA	ESPESSURA(mm)
BID.03.4300	-	4,300
BID.03.4305	-	4,305

EMBALAGEM COM 01 PEÇA

**13** **BASTÃO DO INJETORES DENSO**  
**16600 - EB70A (FRONTIER | TRANSIT)**  
 Comprimento 125,85mm

CÓD. ROBIEL	REFERÊNCIA	ESPESSURA(mm)
BID.04.4300	-	4,300
BID.04.4305	-	4,305

EMBALAGEM COM 01 PEÇA

**13** **BASTÃO DO INJETORES DENSO**  
**1465A054 (TRITON)**  
 Comprimento 125,90mm

CÓD. ROBIEL	REFERÊNCIA	ESPESSURA(mm)
BID.05.4300	-	4,300
BID.05.4305	-	4,305

EMBALAGEM COM 01 PEÇA

**13** **BASTÃO DO INJETORES DENSO**  
**6700 (SINOTRUK)**  
 Comprimento 77,50mm

CÓD. ROBIEL	REFERÊNCIA	ESPESSURA(mm)
BID.06.4300	-	4,300
BID.06.4305	-	4,305

EMBALAGEM COM 01 PEÇA



**324.44.001**

Ferramenta de Retífica do Alojamento do Bastão dos Injetores Denso Ø 4,300mm  
 324.44.0011 - Haste Ø4,300mm



**324.44.002**

Ferramenta de Retífica do Alojamento do Bastão dos Injetores Denso Ø 4,305mm  
 324.44.0021 - Haste Ø4,305mm



UTILIZE A CÂMERA DO SEU CELULAR PARA ESCANEAR O QR CODE E OBTER MAIS INFORMAÇÕES TÉCNICAS DOS PRODUTOS EM NOSSO APLICATIVO **ROBIEL**

BAIXE NOSSO NOVO APP

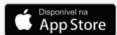

## INJETORES DENSO G2 | G3

Mitsubishi L200 Triton  
Nissan Frontier Tailandesa  
Toyota Hilux

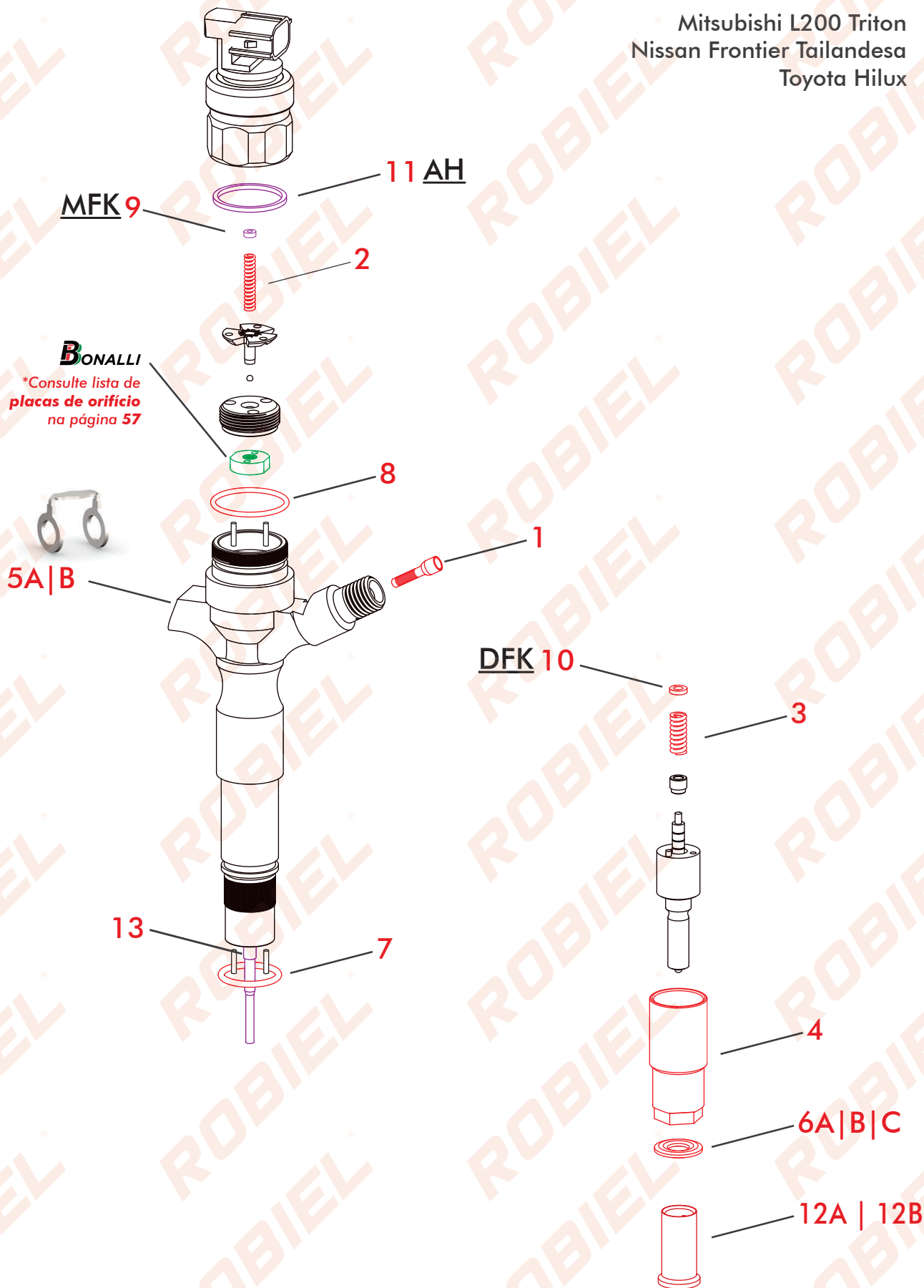

**410.00.35 REPARO DO INJETOR DENSO TOYOTA HILUX**

CÓD. REFERÊNCIA				
Nº	CÓD. ROBIEL	REFERÊNCIA	DESCRIÇÃO	EMB.
5A	602.08.13	-	Arruela de Retorno	05pç.
6B	608.16.19	-	Arruela	04pç.
7	421.01.720	-	Anel O-ring	04pç.
8	421.02.318	-	Anel O-ring	04pç.



**410.00.36 REPARO DO INJETOR DENSO NISSAN FRONTIER**

CÓD. REFERÊNCIA				
Nº	CÓD. ROBIEL	REFERÊNCIA	DESCRIÇÃO	EMB.
5B	602.08.14	-	Arruela de Retorno	05pç.
6A	607.14.20	-	Arruela	04pç.
7	421.01.720	-	Anel O-ring	04pç.
8	421.02.318	-	Anel O-ring	04pç.



**PEÇAS AVULSAS**

Nº	CÓD. ROBIEL	REFERÊNCIA	DESCRIÇÃO	EMB.
1	200.02.01	093152-0320	Filtro do Injetor Denso	04pç.
2	225.01.39	-	Mola do Solenóide Denso	06pç.
3	225.01.40	-	Mola do Calço do Bico Injetor Denso Toyota	06pç.
4	315.06.54	0 950 810 760	Porca do Bico Denso	04pç.
5A	602.08.13	-	Arruela Dupla do Cano de Retorno Toyota	08pç.
5B	602.08.14	16635-84800	Arruela Dupla do Cano de Retorno Nissan	04pç.
6A	607.14.20	MN155904	Assento do Bico L200 Triton	48pç.
6B	608.16.19	-	Assento do Bico Hilux 3.0 - 2,00mm	48pç.
6C	608.16.30	-	Assento do Bico Hilux 3.0 - 3,00mm	12pç.
7	421.01.720	F 00R OPO 397	Anel do Injetor Toyota Hilux 3.0	12pç.
8	421.02.318	-	Anel de Vedação do Solenóide	12pç.
12A	220.03.08	F 00R J02 537   F 00R J03 561 6.000.900.262	Capa Protetora do Bico Injetor Ø 7,00mm	01ct.
12B	220.03.09	F 00H 410 849   F 002 C88 080 6.000.900.076	Capa Protetora do Bico Injetor Ø 9,00mm	01ct.



**1**  

**2**  

**3**  

**4**  

**5A**  

**5B**  

**6A**  **Ø INT: 7,30mm**  
**Ø EXT: 13,70mm**  
**ESP: 1,90mm** 

**6B**  **Ø INT: 7,00mm**  
**Ø EXT: 16,00mm**  
**ESP: 2,00mm** 

**6C**  **Ø INT: 7,00mm**  
**Ø EXT: 16,00mm**  
**ESP: 3,00mm** 

**7**  

**8**  

**12A**  

**12B**  

9	CALÇO DA FORÇA DA MOLA DA BOBINA (MFK)		
	Ø Interno: 1,80 Ø Externo: 4,00		
	CÓD. ROBIEL	REFERÊNCIA	ESPESSURA(mm)
	801.04.12	-	1,20
	801.04.125	-	1,25
	801.04.13	-	1,30
	801.04.135	-	1,35
	801.04.14	-	1,40
	801.04.145	-	1,45
	801.04.15	-	1,50
EMBALAGEM COM 06 PEÇAS			

10	CALÇO DA FORÇA DA MOLA DO BICO (DFK)		
	Ø Interno: 3,00 Ø Externo: 5,70		
	CÓD. ROBIEL	REFERÊNCIA	ESPESSURA(mm)
	803.02.130	-	1,30
	803.02.135	-	1,35
	803.02.140	-	1,40
	803.02.145	-	1,45
	803.02.150	-	1,50
	803.02.155	-	1,55
	803.02.160	-	1,60
	803.02.165	-	1,65
	803.02.170	-	1,70
	803.02.175	-	1,75
	803.02.180	-	1,80
	803.02.190	-	1,90
	803.02.200	-	2,00
EMBALAGEM COM 06 PEÇAS			

11	CALÇO DE AJUSTE DO CURSO DA INDUTÂNCIA (AH)		
	Ø Interno: 21,40 Ø Externo: 24,30		
	CÓD. ROBIEL	REFERÊNCIA	ESPESSURA(mm)
	821.24.150	-	1,50
	821.24.151	-	1,51
	821.24.152	-	1,52
	821.24.153	-	1,53
	821.24.154	-	1,54
	821.24.155	-	1,55
	821.24.156	-	1,56
	821.24.157	-	1,57
	821.24.158	-	1,58
	821.24.159	-	1,59
	821.24.160	-	1,60
	821.24.161	-	1,61
	821.24.162	-	1,62
	821.24.163	-	1,63
	821.24.164	-	1,64
	821.24.165	-	1,65
	821.24.166	-	1,66
	821.24.167	-	1,67
	821.24.168	-	1,68
	821.24.169	-	1,69
	821.24.170	-	1,70
EMBALAGEM COM 10 PEÇAS			

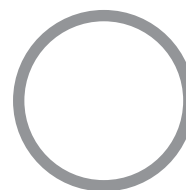

**13** **BASTÃO DO INJETORES DENSO 5160**  
Comprimento 79,20mm 

CÓD. ROBIEL	REFERÊNCIA	ESPESSURA(mm)
BID.01.4300	-	4,300
BID.01.4305	-	4,305

**EMBALAGEM COM 01 PEÇA**



**13** **BASTÃO DO INJETORES DENSO 6490**  
Comprimento 66,70mm 

CÓD. ROBIEL	REFERÊNCIA	ESPESSURA(mm)
BID.02.4300	-	4,300
BID.02.4302	-	4,302
BID.02.4305	-	4,305

**EMBALAGEM COM 01 PEÇA**



**13** **BASTÃO DO INJETORES DENSO 23670-0L020 (HILUX 3.0)**  
Comprimento 117,70mm 

CÓD. ROBIEL	REFERÊNCIA	ESPESSURA(mm)
BID.03.4300	-	4,300
BID.03.4305	-	4,305

**EMBALAGEM COM 01 PEÇA**



**13** **BASTÃO DO INJETORES DENSO 16600 - EB70A (FRONTIER | TRANSIT)**  
Comprimento 125,85mm 

CÓD. ROBIEL	REFERÊNCIA	ESPESSURA(mm)
BID.04.4300	-	4,300
BID.04.4305	-	4,305

**EMBALAGEM COM 01 PEÇA**



**13** **BASTÃO DO INJETORES DENSO 1465A054 (TRITON)**  
Comprimento 125,90mm 

CÓD. ROBIEL	REFERÊNCIA	ESPESSURA(mm)
BID.05.4300	-	4,300
BID.05.4305	-	4,305

**EMBALAGEM COM 01 PEÇA**



**13** **BASTÃO DO INJETORES DENSO 6700 (SINOTRUK)**  
Comprimento 77,50mm 

CÓD. ROBIEL	REFERÊNCIA	ESPESSURA(mm)
BID.06.4300	-	4,300
BID.06.4305	-	4,305

**EMBALAGEM COM 01 PEÇA**



**324.44.001**

Ferramenta de Retífica do Alojamento do Bastão dos Injetores Denso Ø 4,300mm  
324.44.0011 - Haste Ø4,300mm



**324.44.002**

Ferramenta de Retífica do Alojamento do Bastão dos Injetores Denso Ø 4,305mm  
324.44.0021 - Haste Ø4,305mm



**415.00.031** KIT DE CALÇOS PARA REPARAÇÃO DE INJETORES DENSO | SIEMENS

Nº	CÓDIGOS	DESCRIÇÃO	ESPESSURAS(mm)	Peças por Medida
AH	821.24.150 - 821.24.170	Calço do Solenóide do Injetor	1,50 à 1,70	12 peças
MFK	801.04.12 - 801.04.15	Calço da Pré-Injeção do Injetor	1,20 à 1,50	12 peças
DFK	800.00.290 - 800.00.310	Calço do Injetor Denso G2	2,90 à 3,10	12 peças
DFK	803.02.130 - 803.02.160	Calço Ajuste do Bico Denso G2 G3 Siemens	1,30 à 1,60	12 peças
-	814.18.090 - 814.18.100	Calço de Ajuste Piezo Elétrico Siemens	0,90 à 1,00	12 peças

**TOTAL DE 612 PEÇAS**

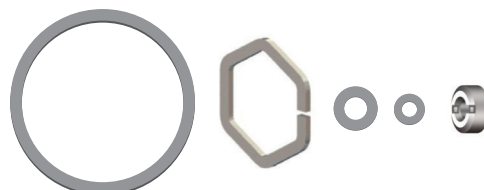

**323.01.3241**

Morsa Giratória para Bancada com Pino Trava



**324.15.01**

Suporte de Montagem e Desmontagem de Injetores



**324.15.04**

Mordente para Injetores Denso



**324.13.322**

Ferramenta da Válvula do Injetor Denso



**323.02.121**

Escova para Limpeza e Remoção de Resíduos Ø 12,00mm



**323.50.20**

Kit de Reparação do Filtro do Injetor Denso



**323.50.083**

Kit de Reparação para Injetores Denso G1 | G2 | G3 Siemens/Continental



## B03.03.P140

<b>Número do Injetor</b>	A2C59517051	<b>Motor</b>	Puma 2.2 e 3.2 16V - Euro 5
<b>Aplicações</b>	Ford Ranger / Transit 2.2/3.2 - Euro 5		2012 - 2017



## B05.03.L020

<b>Número do Injetor</b>	095000-544	<b>Motor</b>	1 KD-FTV
	095000-592		
	095000-822		
	095000-829		
	095000-778		
	095000-754		
<b>Aplicações</b>	Hilux Land Cruiser 3.0		2005 - 2010



## B05.03.L090

<b>Número do Injetor</b>	295050-018	<b>Motor</b>	1KD - 3.0 / 2KD - 2.5
	295050-052		
	295050-020		
	295050-046		
<b>Aplicações</b>	Hilux 3.0 / Land Cruiser / Vigo 3.0 VNT - Euro 4		2010 - 2012



## B05.03.0576

<b>Número do Injetor</b>	095000-576	<b>Motor</b>	4M41 - 3.2
	095000-811		
<b>Aplicações</b>	Pajero Sport / Dakar / Full / Montero		2012-2016



## B05.03.0560

<b>Número do Injetor</b>	095000-560	<b>Motor</b>	4D56 - 2.5
<b>Aplicações</b>	L200 Triton		2008 - 2018



## B05.03.0580

<b>Número do Injetor</b>	095000-580	<b>Motor</b>	Puma 2.4 16V
<b>Aplicações</b>	Ford transit / Land Rover Defender - Euro 3		2007 - 2011
	Citroën Jumper		2007 - 2011



## B05.03.0625

<b>Número do Injetor</b>	095000-625	<b>Motor</b>	YD 2.5 DDTI - 16V DOHC
<b>Aplicações</b>	Nissan Frontier / Navara / Pathfinder YD 25		2005 - 2013



## B05.03.0648

<b>Número do Injetor</b>	095000-648	<b>Motor</b>	JD 6090
<b>Aplicações</b>	John Deere 8530 S450 2005_11 / Tractor		2006 - 2009



UTILIZE A CÂMERA DO SEU CELULAR PARA ESCANEAR O QR CODE E OBTER MAIS INFORMAÇÕES TÉCNICAS DOS PRODUTOS EM NOSSO APLICATIVO **ROBIEL®**

BAIXE NOSSO NOVO APP



**INJETORES SIEMENS VDO | CONTINENTAL**

Ford Ranger

INJETORES
SW 5006
77550

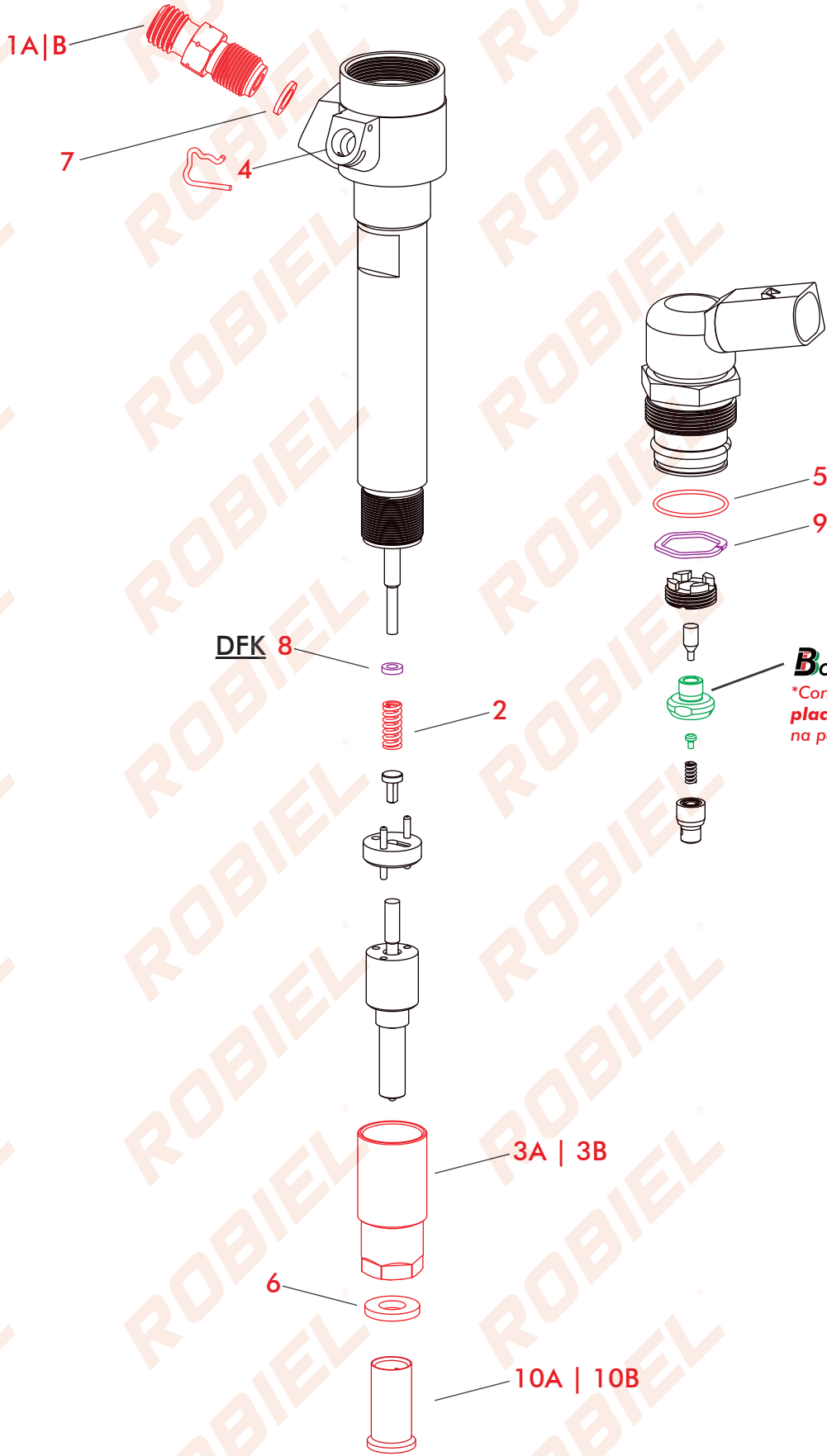

**PEÇAS AVULSAS**

Nº	CÓD. ROBIEL	REFERÊNCIA	DESCRIÇÃO	EMB.
1A	165.02.06	F 00V C16 017	Conexão de Pressão do Injetor	01pç.
1B	165.02.061	-	Conexão c/ Microfiltro Injetores Bosch   Siemens <sup>M12X 1,50mm</sup> <sub>M12 X 1,00mm</sub>	01pç.
2	225.01.41	-	Mola do Bico do Injetor Siemens	06pç.
3A	315.06.55	-	Porca do Bico Injetor Siemens	04pç.
3B	315.06.61	BK2Q9K546AG   A2C59517051 5WS40745	Porca do Bico Ford Ranger / Transit / Troller - 2.2   3.2	04pç.
4	335.03.00	-	Trava do Retorno do Bico Injetor Siemens	04pç.
5	421.01.851	-	Anel do Solenóide do Injetor Siemens	12pç.
6	607.15.20	-	Assento do Bico Siemens Ford Ranger	01ct.
7	805.09.05	F 00V C17 003   F 00R OP0 004	Calço da Conexão do Injetor	12pç.
10A	220.03.08	F 00R J02 537   F 00R J03 561 6.000.900.262	Capa Protetora do Bico Injetor Ø 7,00mm	01ct.
10B	220.03.09	F 00H 410 849   F 002 C88 080 6.000.900.076	Capa Protetora do Bico Injetor Ø 9,00mm	01ct.
R1	001.08.001	BB3Z9A564E	Mangueira de Retorno dos Injetores - Ranger 3.2 20v - 2013 a 2018	01pç.

**1A**  C/ Bastão



**1B**  C/ Microfiltro



**2** 



**3A** 



**3B** 



**4** 



**5** 



**6**  Ø INT: 7,30mm  
Ø EXT: 15,00mm  
ESP: 2,00mm



**7**  Ø INT: 5,50mm  
Ø EXT: 9,40mm  
ESP: 0,50mm



**10A** 



**10B** 



**R1** 



**9 CALÇO DO AJUSTE DO PIEZO ELÉTRICO SIEMENS**   
Ø Interno: 16,00 Ø Externo: 18,00

CÓD. ROBIEL	REFERÊNCIA	ESPESSURA(mm)
814.18.090	-	0,90
814.18.091	-	0,91
814.18.092	-	0,92
814.18.093	-	0,93
814.18.094	-	0,94
814.18.095	-	0,95
814.18.096	-	0,96
814.18.097	-	0,97
814.18.098	-	0,98
814.18.099	-	0,99
814.18.100	-	1,00

**EMBALAGEM COM 06 PEÇAS**

**8 CALÇO DA FORÇA DA MOLA DO BICO SIEMENS 5W S5000|7750 (DFK)**   
Ø Interno: 3,00 Ø Externo: 5,70

CÓD. ROBIEL	REFERÊNCIA	ESPESSURA(mm)
803.02.130	-	1,30
803.02.135	-	1,35
803.02.140	-	1,40
803.02.145	-	1,45
803.02.150	-	1,50
803.02.155	-	1,55
803.02.160	-	1,60

**EMBALAGEM COM 06 PEÇAS**

**415.00.031** KIT DE CALÇOS PARA REPARAÇÃO DE INJETORES DENSO | SIEMENS

Nº	CÓDIGOS	DESCRIÇÃO	ESPESSURAS(mm)	Peças por Medida
-	821.24.150 - 821.24.170	Calço do Solenóide do Injetor	1,50 à 1,70	12 peças
-	801.04.12 - 801.04.15	Calço da Pré-Injeção do Injetor	1,20 à 1,50	12 peças
-	800.00.290 - 800.00.310	Calço do Injetor Denso John Deere	2,90 à 3,10	12 peças
DFK	803.02.130 - 803.02.160	Calço de Ajuste do Bico Ford Ranger	1,30 à 1,60	12 peças
-	814.18.090 - 814.18.100	Calço de Ajuste Piezo Elétrico Siemens	0,90 à 1,00	12 peças

**TOTAL DE 612 PEÇAS**

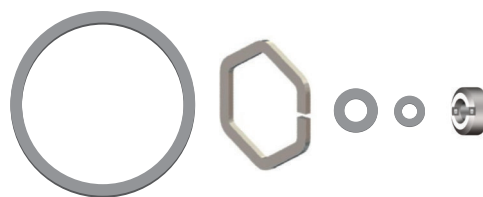

**323.01.324**

Morsa Giratória para Bancada com Pino Trava



**324.15.01**

Suporte de Montagem e Desmontagem de Injetores

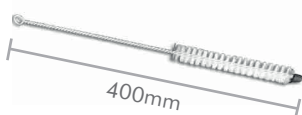

**323.02.121**

Escova para Limpeza e Remoção de Resíduos Ø 12,00mm



**323.50.083**

Kit de Reparação para Injetores Denso G1 | G2 | G3 Siemens/Continental

